

ProScan® III
High Performance Flexible Microscope Automation



ProScan III

High Performance Flexible Microscope Automation Stages

Prior Scientific has designed and manufactured precision equipment for optical microscopy since 1919. This wealth of experience combines with a commitment to customer service to earn Prior Scientific a consistently high reputation for excellent products and support. Our expertise provides a superb foundation for the development of an advanced range of automated systems for microscopy and image analysis.

The ProScan III system sets new standards in automated microscopy. Able to control a large range of microscopy equipment, from motorised stages to shutters, this powerful, precise and versatile system is ideal for many applications.

ProScan III Controller

The ProScan III controller is designed, manufactured and rigorously tested by Prior Scientific, ensuring it is of the highest quality. The compact and modular design is capable of controlling a motorised stage, focus motor, filter wheels, shutters and other equipment with the speed, repeatability and precision required by today's highly demanding applications.

The advanced internal software provides simple control of all accessories via RS232 or USB, and a Software Development Toolkit is supplied to allow simple integration into third party software. Access to acceleration, speed and even drive current is also made available for more advanced users, allowing almost total customisation of the unit. 4 programmable TTL inputs and outputs allow both unit peripherals and external cameras to be controlled via TTL.

Intelligent Control and Versatile Communication

Accessories utilise the plug and play features of the ProScan system, increasing both ease of use and versatility. With the ProScan III each stage's individual settings are stored, complementing the Prior's patented Intelligent Scanning Technology (IST) and enhancing the performance of the ProScan range of stages. The ProScan III also utilises a user friendly, web downloadable firmware upgrade, allowing the user to update the controller as soon as software updates become available and ensuring that their controller is always performing as well as it could possibly be. For the most demanding applications, it is possible to encode all motor axes.

The system includes fast RS232 (1152000) baud and USB communication capability as well as programmable TTL for fast analogue interfacing and external camera control.

As the ProScan III system is compatible with most common microscopy and image analysis programs, the end user can control all aspects of the imaging process from one computer.



ProScan III

High Performance Flexible Microscope Automation Stages

Modular System

The ProScan III's modular approach maximises functionality and versatility whilst reducing space use. The base unit is designed to accommodate a 3 axis system - i.e. a stage and focus - and has a footprint of only 175 x 175 mm. Additional functionality can be added to the unit via ancillary boxes, allowing easy expansion to provide any extra functionality required - for example, 3 filter wheels and 3 shutters. The ability to add more than one such ancillary box allows the creation of an advanced system perfectly suited to the precise needs of the end user.

Both base units and ancillary boxes can be ordered to control either stage and focus movement, or filter wheels and shutters.

Configured for your needs

The ProScan III can be expanded horizontally or vertically to accommodate increased functionality, easing the pressure on the limited space in modern labs*. The ProScan III can be expanded horizontally allowing the controller to fit either on shelves and rack mounted systems, or vertically to reduce the footprint on the available bench space.



* Standard UK configuration is vertical; contact Prior if a horizontal variant is required.



Interactive Control Centre (ICC)

The Interactive Control Centre is much more than a traditional microscope joystick. The screen provides positional feedback whilst the joystick and digipots control stages, focus, filter wheels and shutters. New features on the ICC allow the user to measure distances, label filter wheel positions with dye names (e.g. DAPI, FITC) and take fine control of the stage for intricate movements. The user is given instant feedback regarding the selected fluorophore or the stage position. It also allows basic diagnostics of encoders, TTL, and internal ProScan III settings such as the axis movement speed.



ProScan III

High Performance Flexible Microscope Automation Stages

Precise Motorised Stages

A precise, reliable and accurate stage is vital for many applications, and Prior motorised stages provide exceptionally high levels of accuracy, superb repeatability and excellent resolution.. Specific areas of the stage can be precisely imaged, and stage movement can be programmed so that it moves at in a pattern or at a constant rate - ideal, for example, in tiling or image stitching applications. Furthermore, the positions of multiple areas of interest can be noted and precisely returned to later, making Prior states suitable for long term time lapse experiments.

Thanks to an S-shaped acceleration algorithm, providing quiet and smooth stage movement disruption to samples and the experimental set up is reduced.

Specialised stages, including for hard disk and semiconductor inspection, hardness testing, and other such applications are available. Additionally, a wide range of samples can be observed via specialised inserts, granting even more versatility to the system.

IST

All of our stages come with Prior's patented IST as standard. Prior measures the accuracy of every stage; storing these measurements within the stage itself. The ProScan III combines the requested movements with these measurements to enhance the performance of the stage.

Stage Specifications

Prior uses several standard measurements to accurately report stage performance. All of our performance specifications are based on the Prior method of testing and using a ProScan III controller.

Metric accuracy is the accuracy of the movement compared to a standard - for example, the actual distance moved when ordered to move 1 mm. This statistic is important for virtual slide scanning and tiling images.

Uni-directional repeatability measures the ability of the stage to return to the same point when approaching from the same direction each time (important for OEM customers and multi positional time lapse experiments). This value is the distance to within the stage will return to a previous determined point.

Resolution is the theoretical minimum movement the stage can make and is also known as step size.

Ball screws and motor types determine the speed and accuracy of motorised stages. Larger screw sizes and motors with lower stepper values lead to stages with more accuracy, whilst if speed is a priority a lower screw size and a higher stepper value is better.

Overleaf can be seen just a small selection of the stages we offer. The range available is extensive and most of our stages offer choices in terms of encoder availability, ball screw pitch, and stepper motor step number, offering the ability to purchase a stage perfectly suited to a specific application.

Sample holders

Prior Scientific produces a wide range of sample holders that integrate perfectly with most of our stages. This means that the versatility of the system is greatly increased, with most stages able to work with many sample types, from well plates to Petri dishes to metallurgy samples to conventional glass slides. Custom sample holders can be made, and it is possible for our slide holders to include environmentally controlled conditions to allow imaging of live cells.

ProScan III

High Performance Flexible Microscope Automation Stages



The **H138A** stage for upright microscopes provides an extended x travel range suitable for eight slides at 240 x 76 mm. Stages can be configured with 2 mm ball screws and 20 step motors for high speed applications or 1 mm and 400 step motors for high accuracy applications. Both options can be fitted with high precision encoders and include IST for improved metric accuracy.



The **HWL6AL12** stage (below) is designed for Olympus AL120 wafer handling systems and automatically loads and unloads wafers. It has a travel range of 250 x 210 mm and 2 mm ball screws. Similar stages are available for Nikon systems.



The **H101A** stage for upright microscopes provides a travel range of 114 x 76 mm. Stages can be configured with 2 mm ball screws and 20 step motors for high speed applications or 1 mm and 400 step motors for high accuracy applications. Both options can be fitted with high precision encoders and include IST for improved metric accuracy.

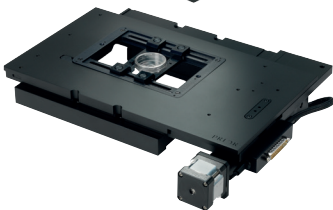

The **H117** stage for inverted microscopes provides a travel range of 114 x 76 mm - excellent for well plates. Stages can be configured with 2 mm ball screws and 20 step motors for high speed applications or 1 mm and 400 step motors for high accuracy applications. Both options can be fitted with high precision encoders and include IST for improved metric accuracy.

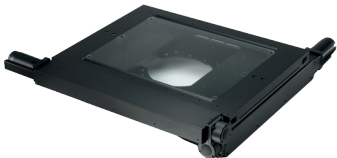

The **H116** stage is one of 3 stages designed for applications involving reflected light - especially industrial ones such as semi-conductor or circuit board inspection. All these have 2 mm ball screws, IST and 0.2 µm repeatability. The **H116** has a travel range of 255 x 215 mm, the **H112** has 300 x 300 mm of movement and the **H105A** has 154 x 154 mm.



Hardness testing (**HT**) stages come in a variety of sizes, from 50 x 50 to 250 x 150 mm. They are equipped to withstand high point loads up to 100 kg. Shown below is the **HLTIIILC** stage, with 108 x 108 mm of travel and 1.5 µm of repeatability.



The **H101F** flat stage range (below) provides the same specifications as the H101A but situates the sample at the highest point of the stage, giving the maximum possible objective clearance.

ProScan III

High Performance Flexible Microscope Automation Stages

HLD 117 Linear Stages

The latest generation of stages from Prior Scientific are based around the H117 stage for inverted microscopes. The addition of linear, rather than stepper motors, means that repeatability is even better (0.15 compared to 0.2 μm) and the range of speeds achievable is greater. A HLD117 stage can go as fast as 300 mm/s and as slow as 1 $\mu\text{m/s}$. At all speeds, movement is smoother and the stage is quieter than conventional slides, whilst a flat top design allows for plenty of space on the stage. These stages are currently available for Nikon, Leica and Olympus inverted research microscopes.

Olympus HLD117 Linear Stage

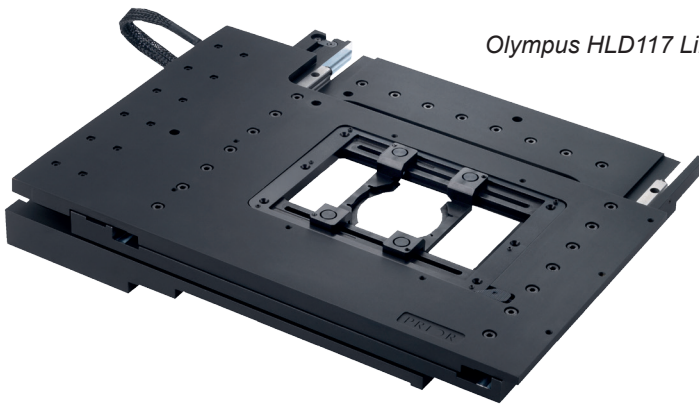

Nikon HLD117 Linear Stage

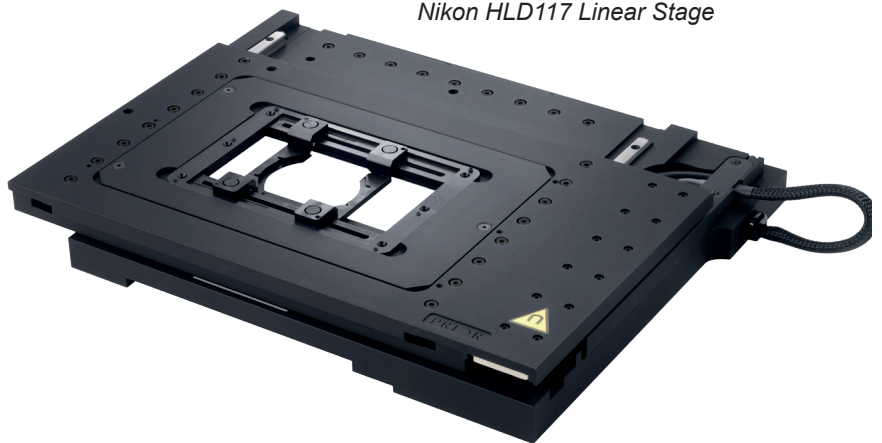

Leica HLD117 Linear Stage

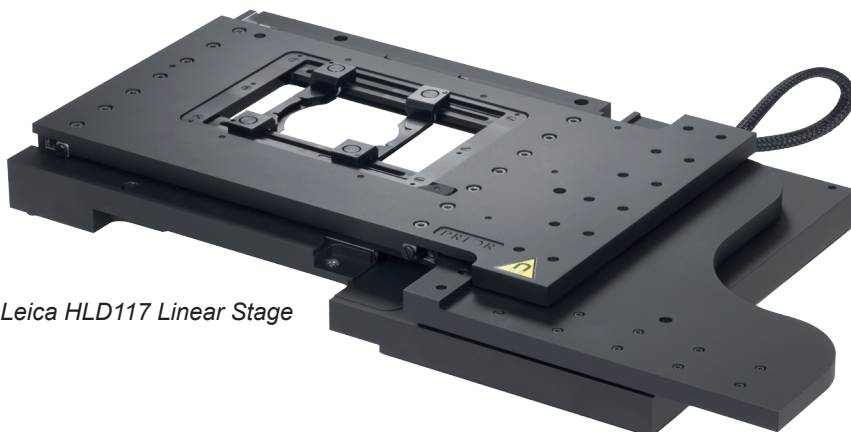

ProScan III

High Performance Flexible Microscope Automation Stages

ProZ Stand

The ProZ stand (right) offers a large focussing range (250 mm) and a large stable platform for imaging. Suitable for a wide range of applications, it is compatible with many stereomicroscopes and microscope modules from both Nikon and Olympus, including the Nikon AZ100 and LV100 microscopes and the Olympus BX2, BX3 & MVX-10 MI microscopes.

With its especially large focus range and wide viewing platform, this is ideal for industrial applications where it is essential to quickly move considerable distances in the Z axis.

A standard BX dovetail is available for basic reflected light applications whilst for transmitted light applications the ProZ Stand has options for both a brightfield/oblique transillumination module that uses a tiltable sliding mirror or a full Köhler illumination module.



Focus Drives

The PS3H122R motorised focus mechanisms gives accurate control of microscope focusing. Encoded focus and optical limit switches are also supported by the ProScan III. Step sizes as small as 2 nm give precise and repeatable positioning for the Z-axis. For high speed focus moves or stereo microscopes the focus can be driven up to 60 rev/s.

Z Axis Focus Block

Ideal for OEM and customised applications, the Motorised Z Axis Focus Block has a large travel range of 38 mm as well as exceptional accuracy with a resolution of 20 nm.

Supporting most Prior stages and able to be driven horizontally or vertically, the Motorised Z Axis Focus Block offers great flexibility when constructing a system. A number of models are available ranging from simple linear stands to ones with offset bases, or designed specifically for either diasopic or episcopic illumination. The latter three can all have motorised stages or sample holders mounted directly onto them.



ProScan III

High Performance Flexible Microscope Automation Stages

Lumen 200Pro

The Lumen 200 Pro produces stable light that is similar to the spectral output of conventional mercury bulbs but greater in intensity, with broader excitation peaks, leading to improved excitation of fluorophores. Each bulb has a lifespan of at least 2000 hours.

The Lumen 200 Pro is wholly compatible and controllable by the ProScan III. An internal filter wheel allows rapid (55 ms) selection of wavelengths, and a motorised variable aperture shutter can control the light transmitted in 1% increments and shut completely in less than 20 ms. The standard Lumen 200 Pro has a filter designed to suit general microscopy needs. The Lumen 210 Pro and the Lumen 220 Pro have extended spectral ranges for specialist applications. The Lumen 210 Pro has increased intensity in the 660nm area making it suitable for the Cy5 and Cy5.5 dyes and the increased transmission in the 730 nm area makes the L220 Pro suitable for Cy7 dye

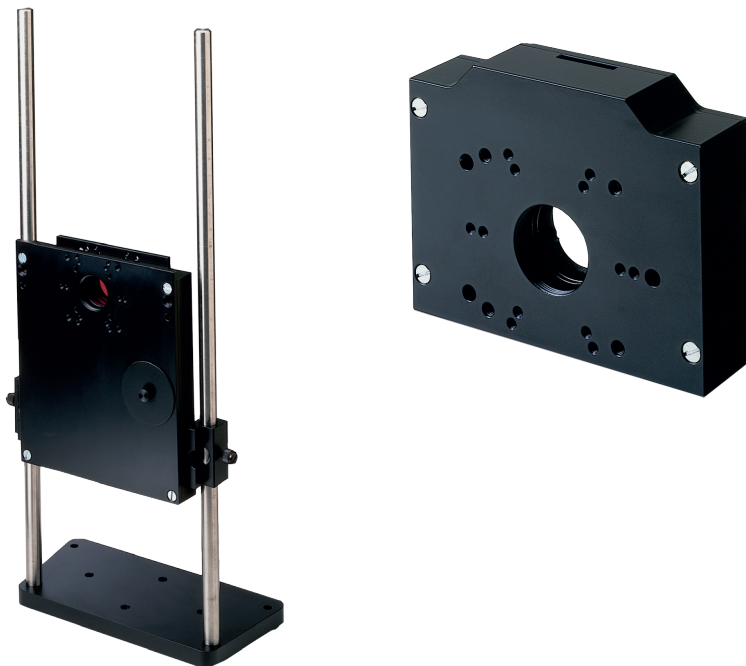

Shutters and Filters

Prior produces a range of shutters and filters that can be controlled via the ProScan III system. 10 or 8 position filter wheels are available which can be stacked together in series. The filters and shutters can be placed on the illumination or emission side of the microscope and the filters have magnetic covers on both sides of the wheel to enable rapid and easy changes of filters. A high speed shutter has a 40 Hz maximum frequency of operation and completely opens or closes within 10 ms.

Brightfield LDB100/101 F

Providing over 10,000 hours of lighting, the LDB100F Brightfield LED (below) is controllable via the ProScan III system. Directly coupling to the microscope to maximise the amount of light transmitted, the LDB100 provides intense, even light of a constant colour temperature for a wide array of applications, including phase contrast, DIC imaging and brightfield viewing. A flip in 550 nm filter allows this illumination device to be used in combination with fluorescent applications as well.



ProScan III

High Performance Flexible Microscope Automation Stages

PL200 Slideloader

The PL200 Slideloader is compatible with the ProScan III system and most upright microscopes, provides the ability to reliably load up to 200 slides automatically onto a ProScan stage. The multi sensor system ensures the slides progress is tracked throughout the handling process ensuring precious slides are delivered safely to the stage, time after time. Barcode readers can be used to ensure the correct linkage of images and slides, and at its fastest an entire load cycle can take no more than fifteen seconds. The PL200 is supported in most image software packages and is supplied with a free software integration kit for OEM customers.

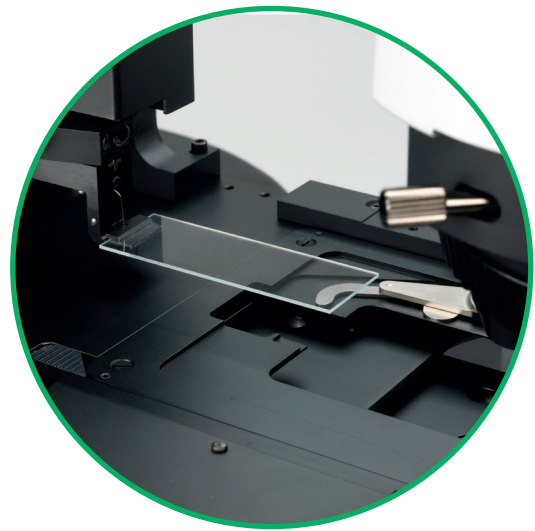

PWL20

The PLW20 Well Plate Loading System is compatible with the ProScan III system and with most inverted microscopes. The PLW20 features a 20 well plate capacity in stainless steel racks for easy cleaning. Compatible with covered and uncovered well plates, the system fits all standard microtitre plates up to 19 mm thick. As with the PL200, bar code readers are available, and at its fastest an entire load cycle takes no more than thirty seconds. The PLW20 is supported in most image software packages and is supplied with a free software integration kit for OEM customers.



ProScan III

High Performance Flexible Microscope Automation Stages

This system diagram of common Prior equipment is a useful guide to the range of products we offer, but please contact Prior to check compatibility of components before ordering. Green indicates the product in question can be controlled by a ProScan III system and so is featured in this guide.

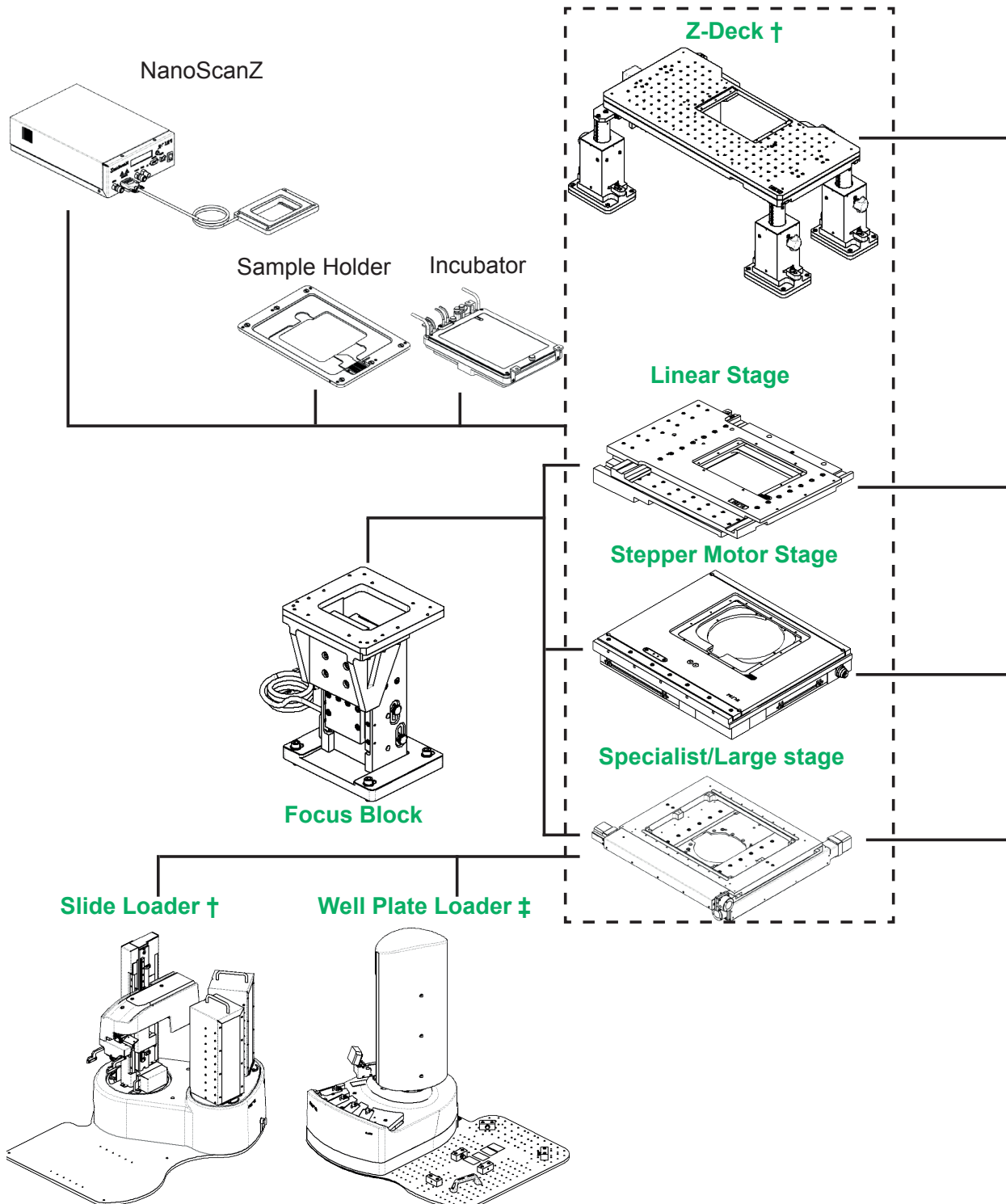

ProScan III

High Performance Flexible Microscope Automation Stages

ProZ Stand*

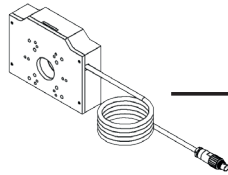
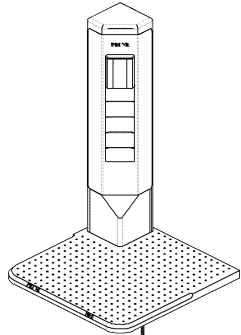

Shutters

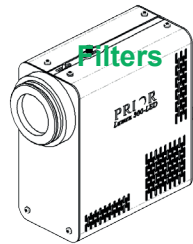
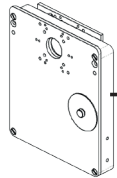

Filters

Lumen 300-LED

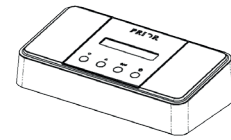

Lumen 100-LED

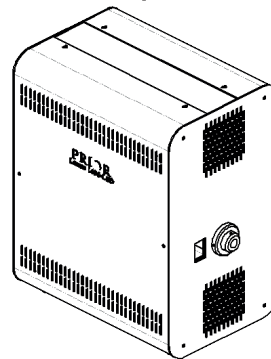

Lumen 1600-LED

Lumen 200 Pro

Lumen 200 S

Lumen 200

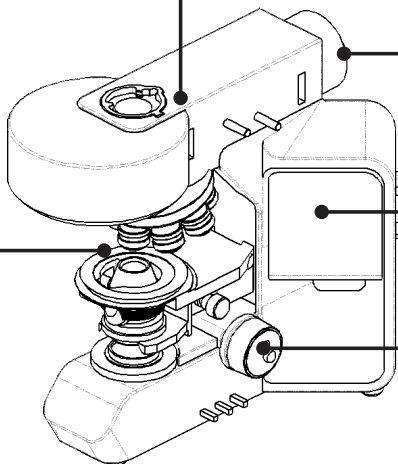
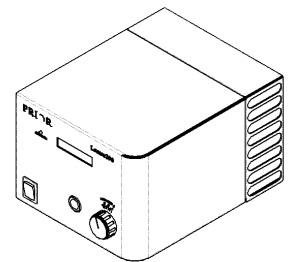

Typical Microscope

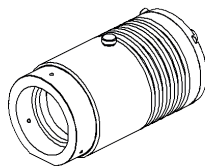

Brightfield

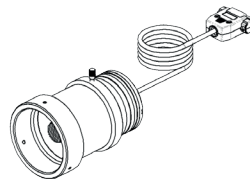

Focus Motor

*The ProZ stand can be used to either move a stage, or parts of specific microscopes.

† Only for use with upright microscopes

‡ Only for use with inverted microscopes

Bold Green indicates a ProScan III is required

Slide and well plate loaders are only compatible with specific stepper motor stages - contact Prior for more information.

ProScan III

High Performance Flexible Microscope Automation Stages

OEM and customised solutions

With years of experience making high quality, precise equipment for microscopy, state-of-the-art facilities, and expert scientists and engineers we are able to customise and create equipment to your exact specifications. Whether it is a slight alteration to an existing product, branded products or entirely unique solutions, we are confident that Prior Scientific will provide excellent service and produce a system exactly matching your needs. The entire process, from initial design and prototyping to testing of the final system, will be carried out by Prior Scientific, allowing us to have complete control over the quality of the finished product.

We also manufacture and distribute a wide variety of other equipment for optical microscopy and related applications. To find out more about Prior Scientific, to see our full range of products, or to discuss how our products, including the ProScan III system, could be of use to you, please email uksales@prior.com or visit www.prior.com

ProScan™ III specifications

Power	Universal Mains Output 110/240 V AC 50-60 Hz
Computer Interface	USB (HID or Virtual COM) RS232
COM Port Communications Protocol	8 bit word 1 stop bit, no parity no handshake, baudrate options of 9600, 19200, 38400 and 115400
Controller	Cube: 175 x 175 x 175 mm
Dimensions	As above, ancillary box adds 59 mm
Weight	3 kg, ancillary box adds kg
Stage Speed	Up to 300 mm/s
Step Size (Focus/Stages)	From 0.01µm for XY and 0.002µm for Z
Repeatability	Typically <1µm
Linear Scales	0.1µm or 0.05µm options available
Ball Screws	Zero backlash, ground recirculation ballscrews, 1, 2, 4 or 5mm available.
Limit Switches	Adjustable in X and Y, optical and mechanical available for Z.