



**Specifications**

iNEXIV VMA-4540V/4540 main body	
Stroke (X x Y x Z)	450 x 400 x 200mm (18" x 16" x 8")
Measurement range with TP (Touch Probe)*1	400 x 400 x 166mm (TP20) 400 x 400 x 170mm (TP200) 450 x 400 x 200mm (with Vision AF)
Measurement range with TP & MCR20*2	325 x 400 x 166mm (TP20) 325 x 400 x 170mm (TP200) 375 x 400 x 200mm (with Vision AF)
Minimum readout	0.1µm
Maximum workpiece weight	40 kg (up to 20 kg accuracy guaranteed)
Maximum permissible error*3	E <sub>UX,MPE</sub> : E <sub>UY,MPE</sub> : 2+6L/1000µm (with Vision AF) E <sub>UX,MPE</sub> : 3+6L/1000µm (with Vision AF) E <sub>UZ,MPE</sub> : 3+L/100µm (with Laser AF or Touch Probing) (L = Length in mm)
Camera	1/3-in. 3CCD color or B/W Progressive scan
Working distance	73.5 mm (63 mm with Laser AF)
Magnification	Optical: 0.35 to 3.5x On screen: 12.6 to 126x with 24-inch WUXGA (1920 x 1200 pixels) monitor
FOV size	13.3 x 10mm to 1.33 x 1mm
Auto focus	Vision AF and optional Laser AF
Illumination	Contour illumination Surface illumination Oblique illumination
Video resolution	640 x 480 (pixels)
Touch probe (optional)	Renishaw® TP200/TP20
Power source	100V-240 V, 50/60 Hz
Power consumption	5A-2.5A (excluding power consumption of host computer and its peripherals)
Dimensions & weight	Main body with table (W x D x H) Controller
Operational environment	Temperature Humidity
Host computer	
CPU	Intel® Core™2 Duo CPU or faster
Memory	4GB or more
Operating system	Windows® 7 32bit
Interface	USB2.0/IEEE1394

\*1 The touch probe can only be attached to the VMA-4540, and not to the VMA-4540V.  
\*2 The iNEXIV-dedicated MCR20 can be used for both TP20 and TP200.  
\*3 Nikon's in-house test at 20°C ±0.5k

**Dimensional diagram**

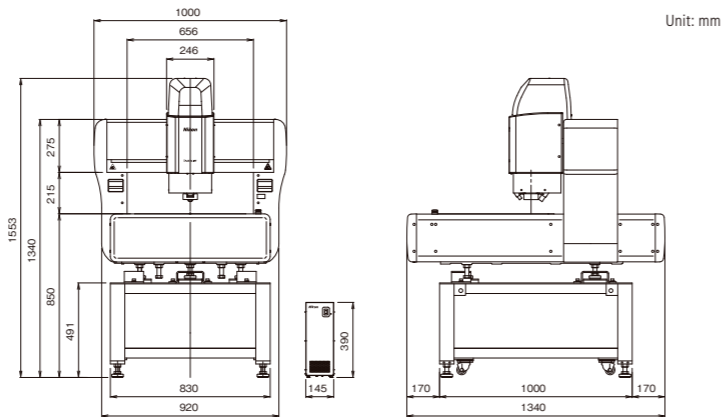

**Measurement range of VMA-4540 with TP20 with 10 mm stylus (without MCR20) (with MCR20)**

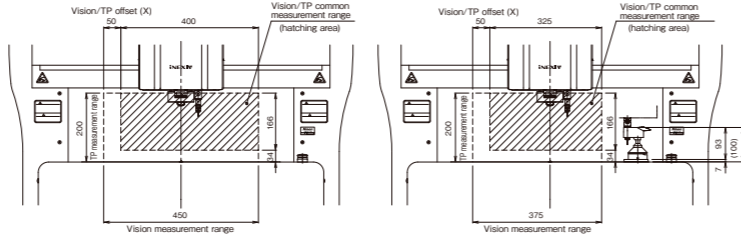

**Top view of stage**

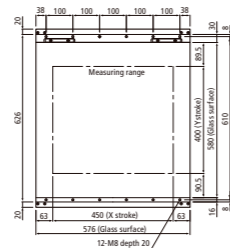

Laser AF is a Class 1 Laser Product **CLASS 1 LASER PRODUCT**

N.B. Export of the products\* in this catalog is controlled under the Japanese Foreign Exchange and Foreign Trade Law. Appropriate export procedure shall be required in case of export from Japan. \*Products: Hardware and its technical information (including software)

Specifications and equipment are subject to change without any notice or obligation on the part of the manufacturer. February 2014 ©2014 NIKON CORPORATION

**WARNING** TO ENSURE CORRECT USAGE, READ THE CORRESPONDING MANUALS CAREFULLY BEFORE USING YOUR EQUIPMENT.

Company names and product names appearing in this brochure are their registered trademarks or trademarks.

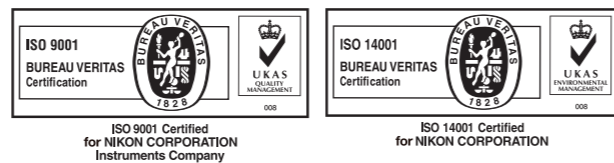

CNC Video Measuring System  
**iNEXIV**  
**VMA-4540V/4540**



Reaching the peak of video measuring systems

# The CNC video measuring system, with a large stage and touch probe\*, is ideal for a wide variety of industrial measuring applications.

The VMA-4540V/4540 is designed for high-accuracy measurement of a variety of workpieces. A wide field of view enables easy confirmation of measurement areas and provides unparalleled operation. Its broader XYZ measurement range, with a longer working distance than ever before, provides ultimate versatility for measurement of both large and tall mechanical parts and uneven surfaces.

\* The touch probe can only be attached to the VMA-4540, and not to the VMA-4540V.

## Wide FOV (Field of View)

A wide FOV of up to 13 mm x 10 mm (at 0.35x) allows easy search and alignment of measuring targets. The 10x zoom with five specific steps provides accurate measurement as well as high-resolution images. An excellent Apochromat objective lens with high NA (0.11) and low distortion has been specially designed for the iNEXIV series, providing crisp, clear images.

Optical magnification		0.35x	0.6x	1x	1.8x	3.5x
FOV size on stage	Horizontal x vertical (mm)	13.3 x 10.0	7.8 x 5.8	4.7 x 3.5	2.6 x 1.9	1.33 x 1.00
1/3" CCD size	Horizontal x vertical (mm)	4.8 x 3.6				
Video magnification		36				
Total magnification on video window (640 x 480 pixels)*		12.6	21.6	36	64.8	126
Pixel size (µm)		21.8	12.6	7.36	4.25	2.15
Size of objects on video window (640 x 480 pixels)	0.01x (mm)	0.126	0.216	0.36	0.648	1.26
	0.1x (mm)	1.26	2.16	3.6	6.48	12.6
	1x (mm)	12.6	21.6	36	64.8	126

\* On a 24-inch WUXGA (1920 x 1200 pixels) monitor, recommended for the VMA series.

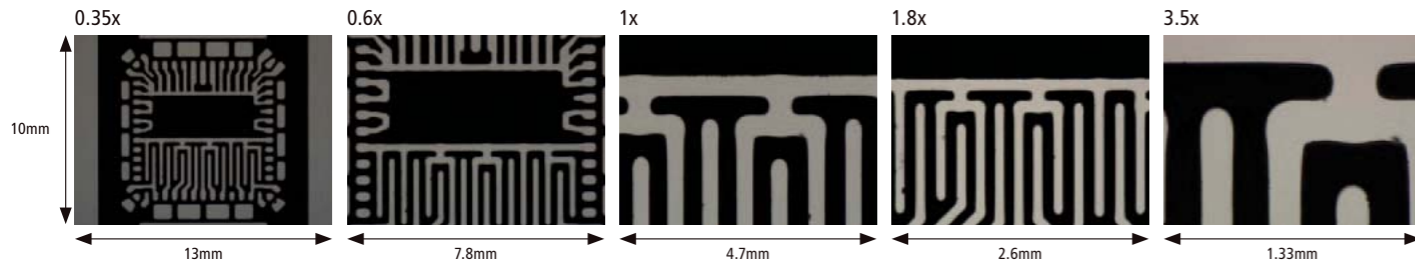

## Robust 73.5 mm working distance

A long 73.5 mm working distance minimizes the possibility of contact between the objective lens and valuable parts. It is ideal for measuring large step heights, tall bosses and deep holes.

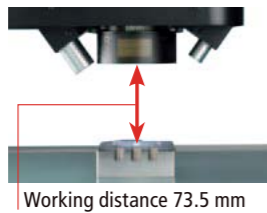

## Large measuring range of 450 mm (X) x 400 mm (Y) x 200 mm (Z)

The large 450 mm x 400 mm XY stage stroke supports measurements of large samples and mass inspections of multiple parts all at once. An extended 200 mm Z stroke is perfect for tall workpieces.

## Fast and accurate vision AF (Auto Focus)

The VMA-4540V/4540 series is equipped with highly repeatable vision AF that offers high-speed, high-precision focusing and height/depth measurement. Non-contact measurement using vision AF does not damage or deform parts, and does not necessitate fixing.

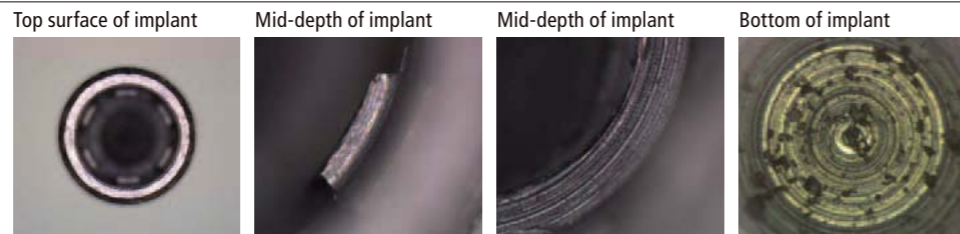

Even the bottom of a small diameter hole can be brought into correct focus.

## Laser AF (option)

The Laser AF with a long 63 mm working distance is optionally available, enabling height measurement of flat surfaces with high repeatability, in keeping a wide FOV at a low magnification.

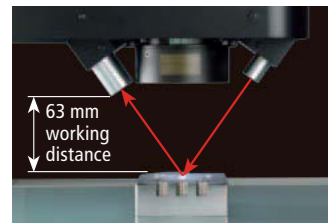

## Versatile illuminations

The VMA-4540V/4540 is equipped with episcopic (top), diasopic (bottom) and 8-segment ring (with 18-degree oblique angle) LED illuminators. Combining these illuminators with superior optics provides accurate detection of low contrast edges.

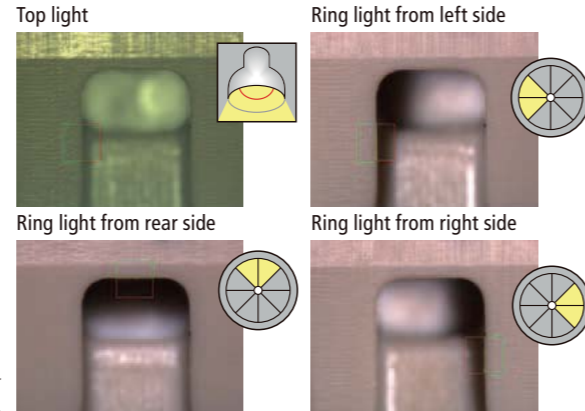

Any 8-segment light can be selected for effective edge detection.

## Intelligent search

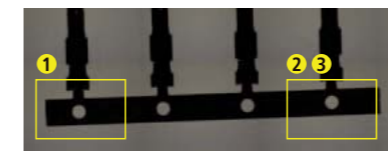

Even when a workpiece is misaligned, the system automatically searches the target location based on the target image recorded in a teaching file, enabling accurate, automatic measurement by eliminating possible detection errors.

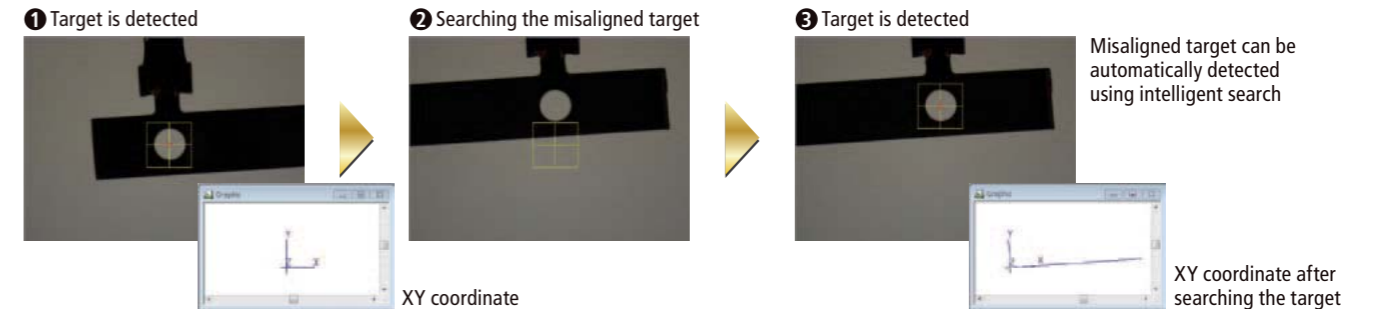

## Digital chart comparator

Deviation of contours can be checked by overlaying charts generated digitally from 2D CAD data onto video images. Digital charts always accompany video images.

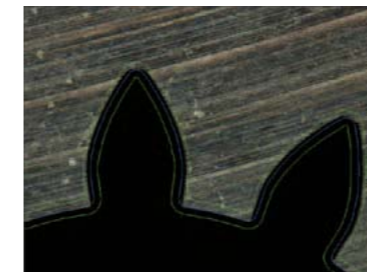

## Touch probe (option)

While the VMA-4540V is only for video measuring, the VMA-4540 is touch-probe ready and accommodates optional Renishaw® TP20 or TP200 touch probes. Touch probes provide measurements of 3D shapes parts where vision AF cannot be used, such as the inner diameter of an oil seal or the clearance angle of an indexable insert. The touch probe offsets from the optical axis, but works coaxially in the same XYZ coordinate system as the optical axis using iNEXIV VMA TP AutoMeasure software.



TP200



## User-friendly standard software iNEXIV VMA AutoMeasure

The VMA AutoMeasure software provides enhanced ease of use and versatility based on Nikon's years of extensive experience in developing the NEXIV series.

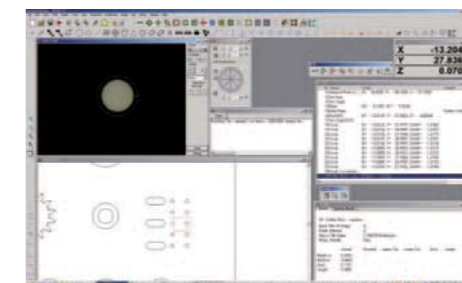

Main program layout



Teaching file selection with interactive guides

## Optional software

**iNEXIV VMA Profiler/CAD Reader:** 2D profile shape analysis program

**iNEXIV VMA Virtual AutoMeasure:** CAD interface off-line teaching support program

**Gear evaluation software:** Analysis of flat gears in terms of pitch deviations, tooth profile errors, tooth space run out, base tangent length, dimension over pin

**NEXIV EDF/Stitching Express:** Image analysis and archiving program for creating an all-in-focus EDF (Extended Depth of Focus) image from multiple images at different Z axis. This also generates a stitched image with super wide FOV from multiple images on the same XY plane.

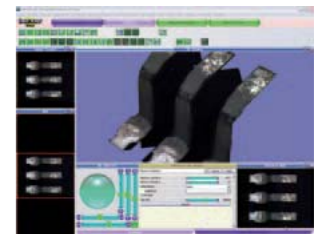

NEXIV EDF/Stitching Express