

M219E 06.2.NF.4



M219EN04

Nikon

Stereoscopic Zoom Microscope

SMZ645/ SMZ660

Instructions

ryf ag
ryf Ryf AG
Bettlachstrasse 2
2540 Grenchen
tel 032 654 21 00
fax 032 654 21 09
www.ryfag.ch

Thank you for purchasing the Nikon product.



This instruction manual is written for the users of Nikon Stereoscopic Zoom Microscopes.

To ensure correct usage, read this manual carefully before operating the instrument.

- It is prohibited to reproduce or transmit this manual in part or whole without Nikon's expressed permission.
- The contents of this manual are subject to change without notice.
- Although every effort has been made to ensure the accuracy of this manual, if you note any points that are unclear or incorrect, contact your nearest Nikon representative.
- Some of the products described in this manual may not be included in the set you have purchased.
- If the equipment is used in a manner not specified by the manufacturer, the protection provided by the equipment may be impaired.

Warning/Caution Symbols Used in This Manual

Though Nikon products are designed to provide you with the utmost safety during use, incorrect usage or disregard of the instructions may cause personal injury or property damage. For your own safety, read the instruction manual carefully and thoroughly before using the product. Do not discard this manual. Always keep it near the product for easy reference. Inside this instruction manual, safety instructions are indicated with the symbols shown below. Be sure to follow the instructions marked with these symbols for your safety.

Symbol	Meaning
 WARNING	Disregarding instructions marked with this symbol may lead to death or serious injury.
 CAUTION	Disregarding instructions marked with this symbol may lead to injury or property damage.

Be sure to always follow these guidelines.



WARNING

1. Intended use of this product

This product is intended only for microscopy. Do not use it for any other purpose.

2. Do not disassemble

Disassembly may result in damage to the instrument. Never disassemble any part except as described in this operation manual. Contact your Nikon representative if you notice any malfunction of this instrument.

3. Check the input voltage

When using an illuminator, check that the input voltage displayed on the power supply of the illuminator matches the operating voltage. Contact your Nikon representative if the displayed voltage does not match the operating voltage. Use of an improperly matched illuminator may result in damage to equipment.

4. Power cord

Always turn the power switch off and unplug the power cord when replacing the lamp of an illuminator as failure to do so may result in electric shock or equipment damage.

5. Heat from the light source

When using an illuminator, do not place cloth or paper or highly flammable materials, such as gasoline, benzene, thinner or alcohol, near the lamp as there is a danger of fire.

- Always use lamps that are of the specified rating only. For the lamp rating, please refer to the operation manual.
- Always turn the power switch off and unplug the power cord when replacing the lamp of a illuminator as failure to do so may result in electric shock or equipment damage.



CAUTION

1. Caution when replacing lamps

The lamp and the surrounding area become very hot during and immediately after using the illuminator. Be careful not to burn yourself. In addition, when replacing a lamp be sure the lamp has cooled sufficiently.

2. Check the light source

Always use lamps that are of the specified rating only. Use of a lamp having a different specification may result in damage to equipment. For the lamp rating, please refer to the operation manual.

1. Installation location

Note the following points when installing the stereoscopic microscope.

- Install the microscope in a location with the temperature between 0° and 40°C, and humidity of less than 80%. If installed in a hot and humid location, mold may form on the lenses or condensation may occur inside, resulting in reduced performance or damage to the microscope.
- Do not install the microscope in a location subject to direct sunlight.
- Install the microscope in a location that is not subject to vibration.
- Install the microscope in a location that is free from dust and dirt.

2. Handle the microscope carefully

The stereoscopic microscope is a precision optical instrument. Handle it carefully and do not subject it to impact. Shock from impact during transportation or operation as well as forcible operations may cause damage to the instrument.

3. Cleaning the lenses

Do not let dust, fingerprints, etc. to get on the lenses. Dirt on the lenses will adversely affect the view of the image. If any lenses become dirty, clean them as described below.

- Use an air blower to blow dust away. If this does not suffice, brush away the dust with a soft brush or gently wipe it away with a piece of gauze.
- Only if the lenses become dirty with fingerprints or grease stains, slightly dampen a piece of soft, clean cotton cloth with absolute alcohol (ethyl alcohol or methyl alcohol) and gently wipe away the dirt. Do not use the same part of the cloth more than once.
- Since absolute alcohol is highly flammable, be careful in handling it so that it does not ignite.
- Observe the manufacturer's handling instructions when handling absolute alcohol.

Be sure to always follow these guidelines.

4. Cleaning painted or plastic parts

Use of silicon cloth is recommended when cleaning painted parts, plastic parts and printed parts. If such a part becomes excessively dirty, wipe it gently with gauze dampened in a mild detergent solution. Do not use organic solvents (such as alcohol, ether, or paint thinner) as this may result in deformation of the part or remove of lettering.

5. Storage

Store the microscope in a location with low humidity where mold is unlikely to form. Do not store the microscope in a location subject to direct sunlight or high temperature and humidity. During storage, place a plastic cover over the equipment to prevent dust accumulation.

6. Regular inspections

Regular inspections are recommended in order to maintain peak performance. Please consult your Nikon representative for details about regular inspections.

Contents

Warning/Caution Symbols Used in This Manual	1
Be sure to always follow these guidelines.	2
⚠ WARNING	2
⚠ CAUTION	3
I Nomenclature	8
II Assembly	10
III Usage	12
1 Preparations For Observation	12
1. Adjust the torque of the focus knob.	12
2. Adjust the interpupillary distance.	12
3. Adjust the diopter.	12
2 Focusing	13
1. Check the working distance.	13
2. Focus on the sample.	13
3 Zoom	14
1. Change the zooming magnification.	14
4 If You Cannot Focus On The Sample Though The Zooming Body Is At The Highest Position.	15
IV Using Accessories	16
1 Reticles	16
2 AL ERG (ERGO) Auxiliary Objective	17
3 SM-S4L 4 X 4 Stage L	18
4 Halogen Illuminators	19
1. Lamp	20
2. Attaching to the stand (only for G-LS)	21
3. Arm for halogen illuminators	21
4. Power supplies	23
5. Lighting area adjustment (only for G-LS)	25
6. Attaching filters (only for C-DLSLS)	25
Antistatic Feature	25
Airtight Feature	25
Table 1: Total Magnification and Real Field	26
Table 2: Observable Sample Heights	27

I Nomenclature

The illustration shows the combination of SMZ645 zooming body, C-W10X eyepieces and C-PS plain focusing stand.

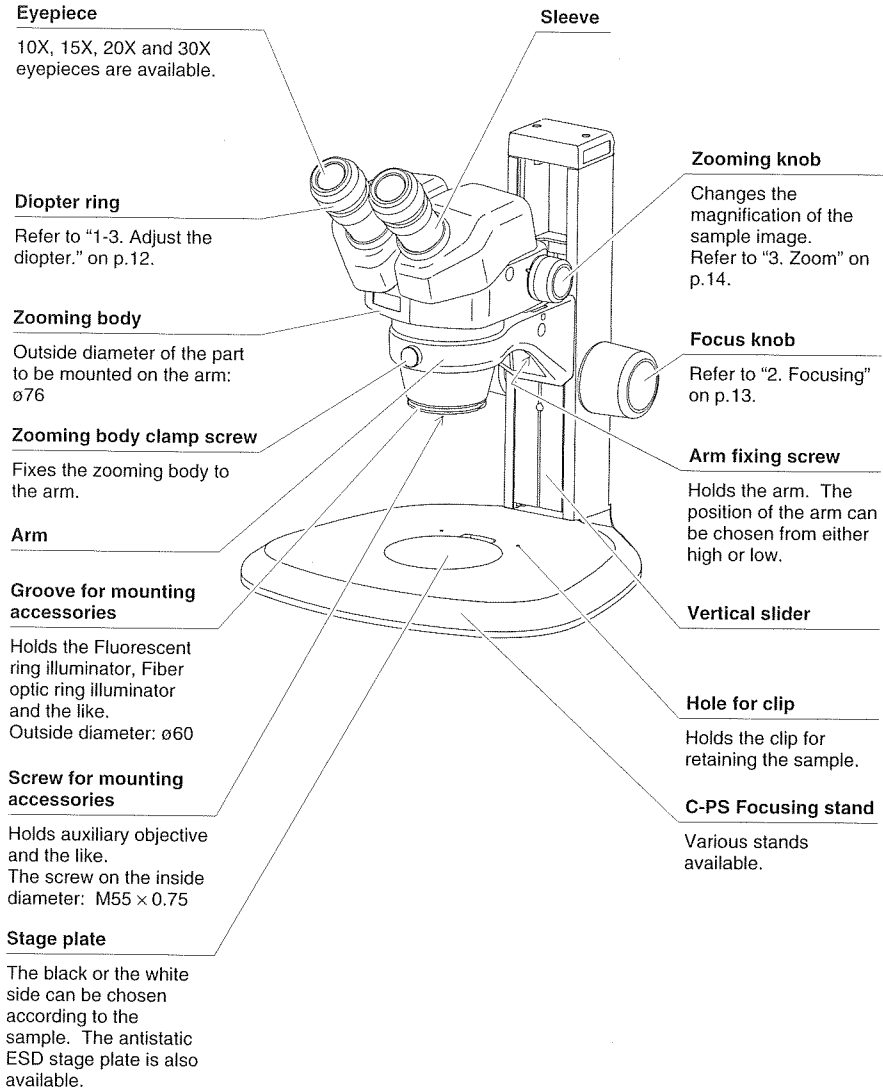

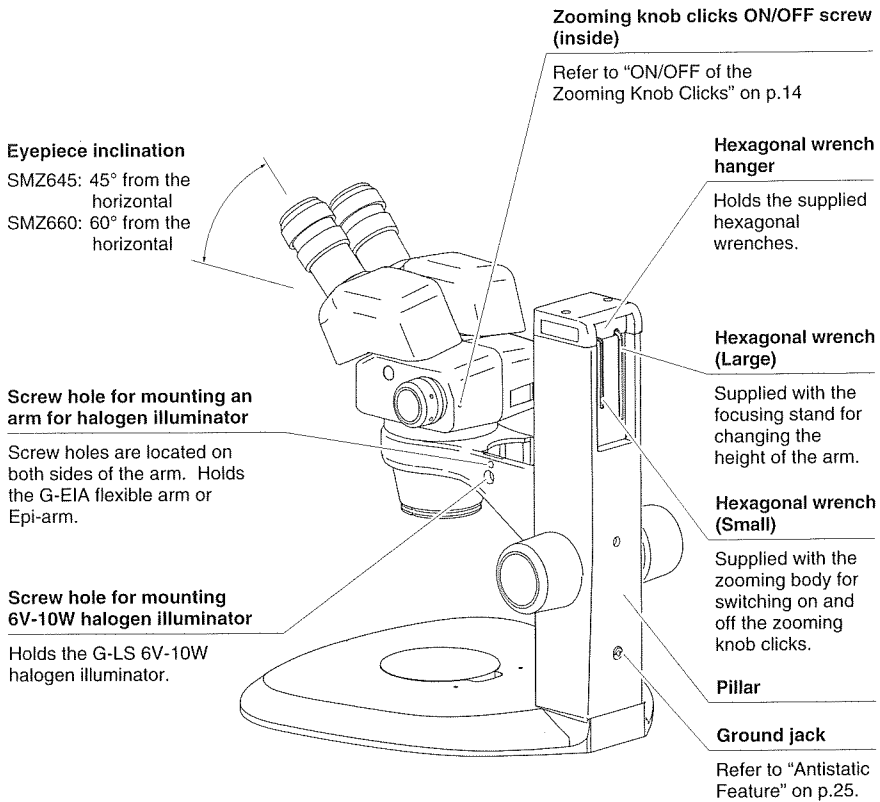

II Assembly

1 Place the stand on the level surface.

2 Mount the stage plate.

Fit the stage plate into the stand base while pushing it against the rim in the direction shown by the arrow in the illustration.

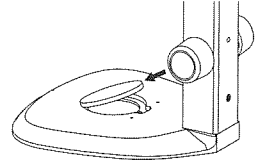

3 The stand arm can be lowered. (If you do not need to lower the arm, jump to step 4.)

Use the hexagonal wrench (large - supplied with the focusing stand) to loosen the arm fixing screw. Reattach the arm using the screw hole at the lower side of the vertical slider. The arm will become 55 mm lower than its original position. Before tightening the screw, make sure that the two pins on the arm fit in the grooves on the vertical slider.

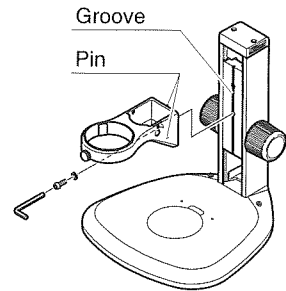

4 Mount the zooming body.

Lightly tighten the zooming body clamp screw to hold the zooming body on the arm.

Note) Do not over-tighten the zooming body clamp screw since it may cause damage to the instrument.

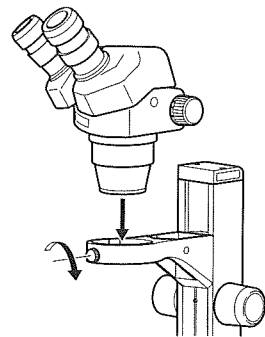

5 Insert the eyepieces into the eyepiece sleeves.

Be sure that it is inserted all the way until it touches the end of the sleeve.

Note) When inserting the 10X eyepiece, assure that it touches the end of the sleeve, because the rubber cover of the 10X eyepiece will obstruct the view of the sleeve end. When inserting, hold the rubber cover not the diopter ring. If not, a failure could result.

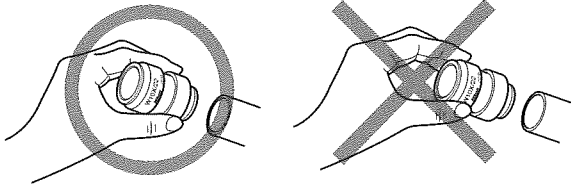
**6 The hexagonal wrenches can be stored in the rear of the pillar.**

Refer to the figure on p.9.

1 Preparations For Observation

1 Adjust the torque of the focus knob.

Adjust the torque of the focus knob so as not to fall down the zooming body on its own weight.

Increasing the torque.

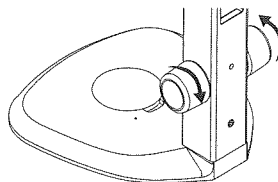

(To reduce the torque, turn the knob in the direction opposite to the arrow.)

2 Adjust the interpupillary distance.

This adjustment should be performed every time the observer is changed since the interpupillary distance differs between individuals. Adjust the interpupillary distance so that the view field for each eye is merged into one. Move while holding each sleeve with both hands.

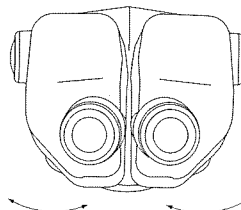

3 Adjust the diopter.

This adjustment should be performed every time the observer is changed since the eyesight differs between individuals.

- 1 Turn the diopter rings on both eyepieces to set them at the 0 position (match the 0 line with the index line).
- 2 Turn the zooming knob to 5X. Focus on the sample using the focus knob. (Refer to “2. Focusing”.)
- 3 Turn the zooming knob to 0.8X. Peering through the left eyepiece with the left eye, focus on the sample using the diopter ring on the left eyepiece. Then, peer through the right eyepiece with your right eye and focus on the sample using the diopter ring on the right eyepiece.
- 4 Repeat steps 2 and 3 until the image is kept focused even though the zooming magnification is changed. This adjustment ensures sharp image throughout the zooming range.



2 Focusing

1 Check the working distance.

The distance between the focus plane and the bottom surface of the zooming body is called “the working distance”. Since the working distance of the SMZ645 and SMZ660 is 115 mm, the focusing will become easier if you set the zooming body at the position where its bottom surface is 115 mm apart from the sample surface.

Refer to the Table 1 (p.26) for the changes in working distances when the auxiliary objective is attached.

2 Focus on the sample.

Turning the left and right focus knobs in the same direction will move the arm (on which the zooming body is mounted) up and down. Thus you can focus on the sample.

3 Zoom

1 Change the zooming magnification.

Turning the zooming knobs on the left and right side of the zooming body will change the magnification of the sample image.

■ Total Magnification

The zooming knob on the right has the indication of the zooming magnification. Total magnification can be calculated by multiplying the eyepiece magnification by the zooming magnification.

Note) When the auxiliary objective is attached, multiply its magnification as well.

■ ON/OFF of the Zooming Knob Clicks

The clicks on the zooming knob can be eliminated.

- 1 Remove the small rubber cap from the rear of the zooming body.
- 2 Insert the supplied hexagonal wrench (small) into the screw hole on the rear of the zooming body.
- 3 Turning the inside screw in the direction opposite to the arrow eliminates the clicks (OFF). Turning the same screw in the direction of the arrow puts on back the clicks (ON).
- 4 Return the small rubber cap to its original position.

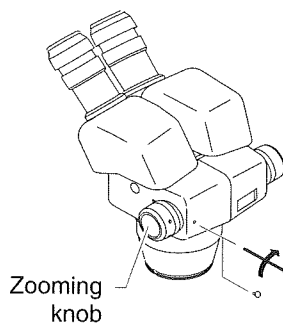



4 If You Cannot Focus On The Sample Though The Zooming Body Is At The Highest Position.

When you use the 0.5X auxiliary objective or observe a tall sample, you may not be able to focus on the sample though turning the focus knob to raise the zooming body to its highest position.

In this case, use the C-ER auxiliary adapter available as an option.

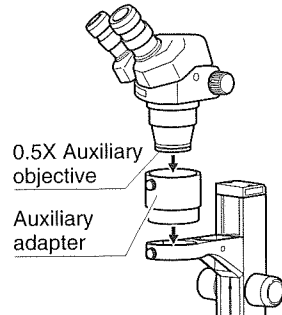
Note) Attach the auxiliary objective first to the zooming body, and then mount the zooming body on the auxiliary adapter.



-  • Refer to the Table 2 on p.27 for the sample heights which may be viewed.

IV Using Accessories

1 Reticles

Your reticles may be attached to the eyepiece. Once remove the field ring (or lens room of the 20X and 30X) from the eyepiece. Attach the reticle with its pattern surface facing down to the eyepiece and reattach the field ring (or lens room).

- Refer to the Table 1 on p.26 for the size of the reticle which may be attached.

Note) The 20X and 30X eyepieces adopt the internal focusing system, and the primary image has the magnification. Use the reticle with 1.3X pattern for 20X eyepiece, and with 1.4X pattern for 30X eyepiece. A reticle with cross hairs or scaled cross hairs is available on order for 10X eyepiece.

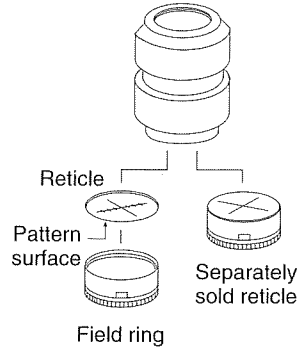

2 AL ERG (ERGO) Auxiliary Objective

Using the AL ERG auxiliary objective allows you to continuously change the eye level through a 40 mm range.

- 1 Rotate the milled ring on the AL ERG to attach it to the zooming body.
- 2 Rotate the focus knobs on the focusing stand to raise or lower the zooming body to set to the height best suited for viewing.
- 3 Rotate the rotation barrel to focus on the sample.
- 4 To change the eye level more, rotate the rotation barrel referring to the eye level scale and focus on the sample using the focus knobs. One graduation of the eye level scale is equivalent to 10 mm of the eye level. The upper the scale, the higher the eye level.

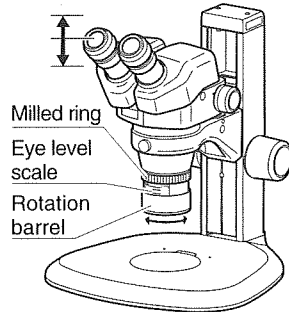

Note) Changing the eye level will change the magnification. The magnification is 0.77X at the highest eye level, and 1.06X at the lowest eye level. To know the exact magnification, calculate it using the reticle with scaled cross hairs, etc.

3 SM-S4L 4 X 4 Stage L

SM-S4L 4 X 4 stage L may be attached by using the C-4SA stage adapter. In this case, use the C-ER auxiliary adapter because the position of the sample will become higher. (Refer to “4. If you cannot focus on the sample though the zooming body is at the highest position.” on p.15.)

- 1 Remove the stage plate from the stand base, and attach the C-4SA stage adapter in place using the fixing screws supplied with the adapter.
- 2 Sufficiently loosen the stage clamp screw of the SM-S4L 4 X 4 stage L. Fit and mount the stage onto the stage adapter with the side equipped with the stage clamp screw facing front. Tighten the stage clamp screw.

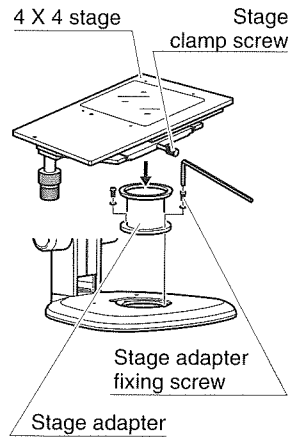

4 Halogen Illuminators

There are two illuminators available: the G-LS of 6V 10W and the C-DSLS of 6V 20W.

G-LS

Lamp Socket A (6V10W)

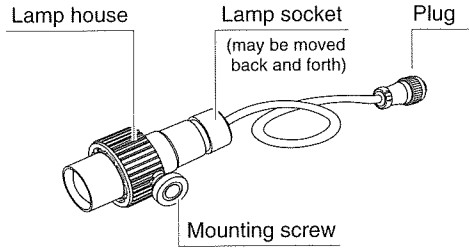

C-DSLS

Illuminator A (6V20W)

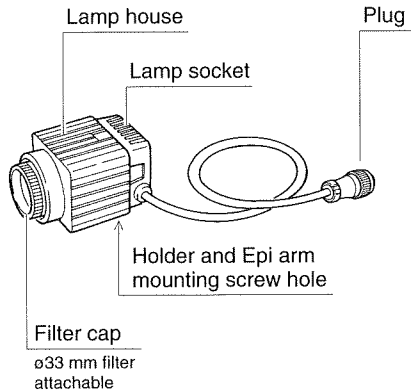

1 Lamp



CAUTION

The lamp and the surrounding area become very hot during and immediately after using the illuminator. Be careful not to burn yourself. In addition, be sure the lamp has cooled sufficiently before replacing a lamp.

Pull the lamp socket from the lamp house and insert the lamp straight into the socket as far as it will go. Only use halogen lamps of the specified rating.

Next, attach the lamp socket to the lamp house.

G-LS

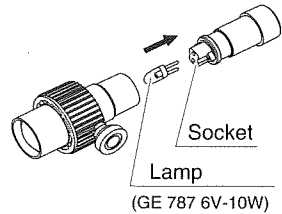

C-DSLS

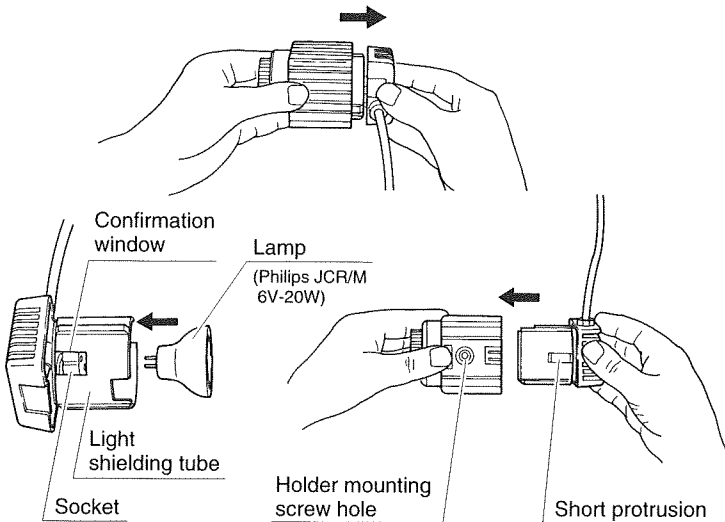

Note) Do not touch the glass part of a lamp with your bare hands as your skin may burn and stick to the lamp, possibly reducing its level of light output or causing damage to the lamp. When replacing a

lamp, handle it through a piece of cloth or through its packaging until replacement is complete. If you get fingerprints on the lamp, wipe gently with a piece of clean cloth dampened with alcohol.

2 Attaching to the stand (only for G-LS)

Set so that the protrusion on the lamp house aligns with the inside of the screw hole on the arm of the stand (screw hole for mounting 6V10W halogen illuminator) and secure it in place from the outside of the arm using the mounting screw.

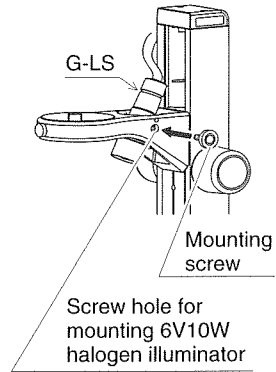

3 Arm for halogen illuminators

It is possible to freely adjust the direction of illumination by using a special arm.

1 G-EIA flexible arm (only for G-LS)

Set so that the protrusion on the lamp house aligns with the inside of the hole in the holder of the flexible arm and secure it in place from the outside of the holder using the mounting screw.

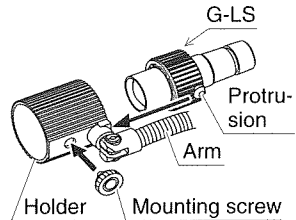

Secure by screwing the mounting screw supplied with the arm into the arm mounting screw hole on the arm of the stand.

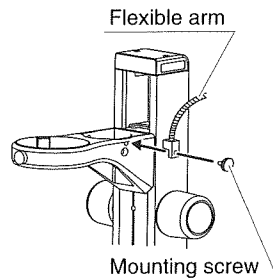

2 Epi arm

Slightly loosen the clamp knob on the arm. Screw in the mounting screw at the end of the Epi arm into the screw hole of the stand (screw hole for mounting an Epi-arm) while turning the joint. Next, securely tighten the nut using the supplied wrench.

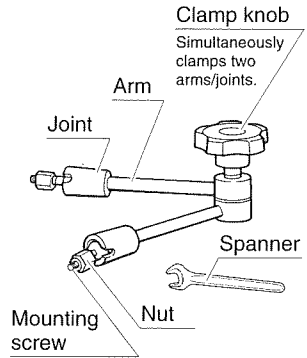

Screw the mounting screw at the other end of the Epi arm into the screw hole on the lamp house in the same manner as described above. Set the lamp house in a position that makes for easy viewing and tighten the clamp knob.

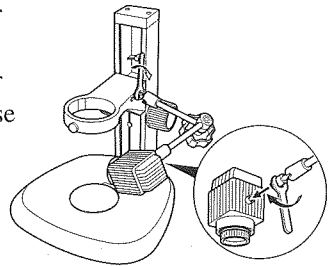

4 Power supplies

Use the Power Supply XN A for regions using 100/120 V power, and the Power Supply TN-PSE30W A for regions using 230 V power. Insert the plug of the Halogen illuminator into the output connector located on the rear of the power supply.

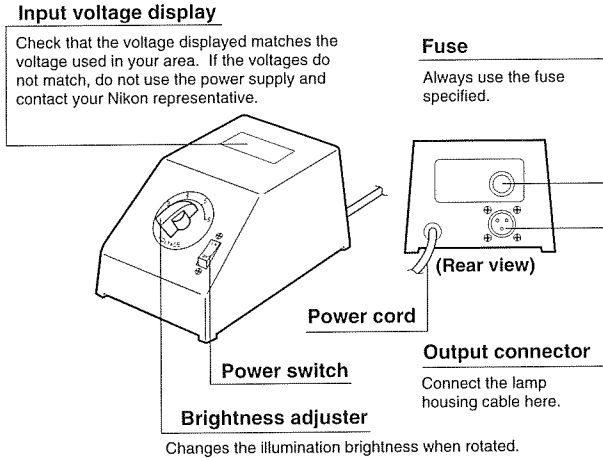

Power Supply XN A (only for regions with 100/120 V power)

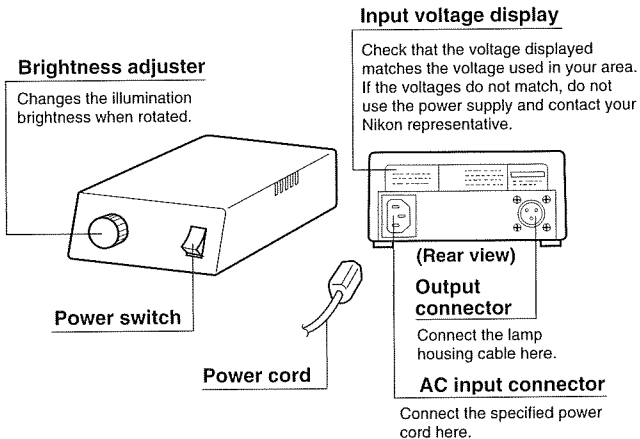

Power Supply TN-PSE30W A (only for regions with 230 V power)

Power Supply XN A (only for regions with 100/120 V power)

Input rating	Power supply for 100V regions only: 100 V AC, 50/60 Hz, 30 W Power supply for 120V regions only: 120 V AC, 50/60 Hz, 30 W
Output rating	3-6 V AC, 3.3 A
Fuse rating	250 V, 1 A

Power Supply TN-PSE30W A (only for regions with 230 V power)

Input rating	230V AC, 50/60Hz, 0.3A
Voltage fluctuation	±10%
Output rating	AC 6V 5A
Internal fuse	Fast acting type, F1A/250V, 5.2 × 20 mm
Operating environment	Altitude: 2000 m max. Temperature: 0° - 40°C (indoor use only) Relative humidity: 85% max. (no condensation) Pollution level: Degree 2 Installation: Category 2
Storage environment	Temperature: -20° - 60°C Relative humidity: 90% max. (no condensation)
Protection class	Class 1
Power cord	Use only the following power supply cord. Using the wrong power cord could result in danger or fire. The protection Class 1 equipment should be connected to PE (protective earth) terminal. • For 220-240V AC area Approved according to EU/EN standards, 3 conductor grounding Type H05VV-F, 3 m long maximum, rated at 250V AC minimum.

5 Lighting area adjustment (only for G-LS)

It is possible to adjust the lighting area by moving the lamp socket back and forth. Adjust the lighting area to allow easy viewing.

6 Attaching filters (only for C-DSLS)

Rotate and remove the filter cap at the end of the lamp house and insert a filter. Use filters that have a diameter of 33 mm and a width of 1.5 ~ 2 mm.

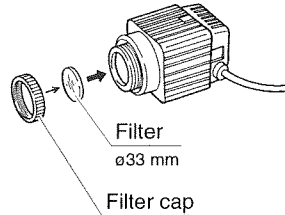

Antistatic Feature

The SMZ645, the SMZ660, the C-PS/C-PSC plain focusing stand and the C-W 10X eyepieces are made antistatic. You can enjoy the benefits of this feature when observing the sample that cannot stand much static. When using the microscope on this purpose, do not forget to change the stage plate to antistatic ESD stage plate, and ground the microscope through the ground jack at the rear of the focusing stand. The $\phi 4$ mm grounding terminal can be inserted in the ground jack.

The following accessories are also made antistatic.

- C-FPS Fluorescence Attachment
- Auxiliary Objectives (all types)
- C-FMB Focusing Mount B
- C-US1 and C-US2 Universal Table Stands

Airtight Feature

The SMZ645, the SMZ660 and the C-W 10X eyepieces are made airtight. This feature may be convenient when using the microscope in the oil-misty environment in the factory or for soldering.

Note) Always attach the rubber cap on the rear of the zooming body and the rubber cover on the eyepiece to hold the airtightness.

Table 1: Total Magnification and Real Field

Auxiliary objectives	Working distance [mm]	Eyepieces															
		10 X		15 X		20 X		30 X		10 X		15 X					
		Total magnification	Real field [mm]	Total magnification	Real field [mm]	Total magnification	Real field [mm]	Total magnification	Real field [mm]	Total magnification	Real field [mm]	Total magnification	Real field [mm]				
None	115	8 ~ 50 X	27.5 ~ 4.4	12 ~ 75 X	20.0 ~ 3.2	16 ~ 100 X	15.6 ~ 2.5	24 ~ 150 X	8.8 ~ 1.4	2.3 ~ 14.5 X	94.8 ~ 15.2	3.5 ~ 21.8 X	69.0 ~ 11.0	4.6 ~ 29 X	53.8 ~ 8.6	7 ~ 43.5 X	30.3 ~ 4.8
AL 0.29 X	311	4 ~ 25 X	55.0 ~ 8.8	6 ~ 37.5 X	40.0 ~ 6.4	8 ~ 50 X	31.2 ~ 5.0	12 ~ 75 X	17.6 ~ 2.8	4 ~ 25 X	55.0 ~ 8.8	6 ~ 37.5 X	40.0 ~ 6.4	8 ~ 50 X	31.2 ~ 5.0	12 ~ 75 X	17.6 ~ 2.8
AL 0.5 X	211	5.6 ~ 35 X	39.3 ~ 6.3	8.4 ~ 52.5 X	28.6 ~ 4.6	11.2 ~ 70 X	22.3 ~ 3.6	16.8 ~ 105 X	12.6 ~ 2.0	5.6 ~ 35 X	39.3 ~ 6.3	8.4 ~ 52.5 X	28.6 ~ 4.6	11.2 ~ 70 X	22.3 ~ 3.6	16.8 ~ 105 X	12.6 ~ 2.0
AL 0.7 X	150	12 ~ 75 X	18.3 ~ 2.9	18 ~ 112.5 X	13.3 ~ 2.1	24 ~ 150 X	10.4 ~ 1.7	36 ~ 225 X	5.9 ~ 0.9	12 ~ 75 X	18.3 ~ 2.9	18 ~ 112.5 X	13.3 ~ 2.1	24 ~ 150 X	10.4 ~ 1.7	36 ~ 225 X	5.9 ~ 0.9
AL 1.5 X	61	16 ~ 100 X	13.8 ~ 2.2	24 ~ 150 X	10.0 ~ 1.6	32 ~ 200 X	7.8 ~ 1.3	48 ~ 300 X	4.4 ~ 0.7	16 ~ 100 X	13.8 ~ 2.2	24 ~ 150 X	10.0 ~ 1.6	32 ~ 200 X	7.8 ~ 1.3	48 ~ 300 X	4.4 ~ 0.7
AL 2 X	43.5	6.2 ~ 53 X	35.7 ~ 4.2	9.2 ~ 79.5 X	26.0 ~ 3.0	12.3 ~ 106 X	20.3 ~ 2.4	18.5 ~ 159 X	11.4 ~ 1.3	6.2 ~ 53 X	35.7 ~ 4.2	9.2 ~ 79.5 X	26.0 ~ 3.0	12.3 ~ 106 X	20.3 ~ 2.4	18.5 ~ 159 X	11.4 ~ 1.3
AL ERG	101.6 ~ 47.9																

Table 2: Observable Sample Heights

Table 2: Observable Sample Heights

(C-PS/C-PSC plain focusing stand + C-DS diascopic stand) [mm]

Auxiliary objectives	Arm normal position	Arm lower position	When using auxiliary adapter
None	0 ~ 103	0 ~ 48	55 ~ 159
AL 0.29 X	—	—	—
AL 0.5 X	—	—	0 ~ 48
AL 0.7 X	0 ~ 55	—	6 ~ 111
AL 1.5 X	38 ~ 142	0 ~ 87	94 ~ 198
AL 2 X	55 ~ 159	0 ~ 104	111 ~ 215
AL ERG	0 ~ 123	0 ~ 68	35 ~ 179