

SteREO Discovery.V20

The New Spectrum

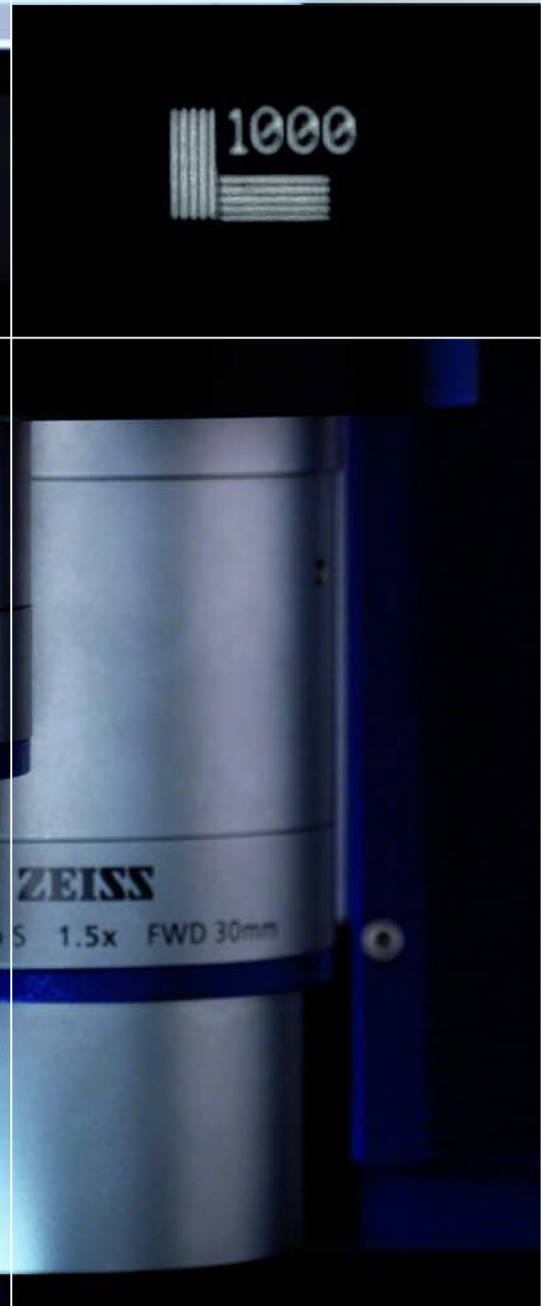

**Zoom Factor 20 in Stereomicroscopy -
More Flexibility Between Overview and
Detail Magnification**



We make it visible.

Fact Innovation: Never Before has the Magnification Spectrum been Larger.

There's a new performance standard in the demanding world of stereomicroscopy: Zoom Factor 20. The factor for the largest spectrum between overview and detail magnification. The microscope: SteREO Discovery.V20. A Carl Zeiss design. And a research instrument with which the pioneer of the CMO principle (Common Main Objective) has once again broken new ground for the future of stereomicroscopy after the telescope principle. The development of the SteREO Discovery.V20 has exceeded the limits of conventional modes of action. Founded on a new technological base and integrated into the SteREO* generation series from Carl Zeiss, SteREO Discovery.V20 is highly impressive and boasts a superior performance profile. For maximum precision and considerably more freedom in biology, medical and industrial labs. The new features:

- planapochromatic corrected microscope bodies with a zoom range of 20:1
- high end magnification of up to 345x (with eyepiece 10x)
- maximum resolution of 1000LP/mm (with objective PlanApo S 2.3x)
- excellent 3D-effect up to the highest magnification
- comfortable, securely reproducible operational and control concept with SyCoP
- seamless integration into the modular system of the SteREO Discovery generation

* SteREO – Stereomicroscopy Redefined in Ergonomics and Optics



teREO Discovery.V20



The Performance Factor: Superiority Can be Documented

At the borders of technical possibilities details become a critical factor. Better optics is responsible for a visible improvement in image information. The easier operation concept delivers faster results. Factors which Carl Zeiss places the utmost importance on in development and consistently optimizes until the peak of performance is reached. The results create new benchmarks. At any place where living objects or material samples are observed, manipulated or documented in detail, three-dimensionally and with high resolution or high contrast.

1A in 3D: Spatial impression

With SteREO Discovery.V20, higher magnifications can also be realized with smaller lenses thanks to the large zoom range of the microscope body. The smaller stereo angles associated improve the 3D impression of the microscopic image. The result: you remain more relaxed during observation and notice even the smallest details.

Secure the highest magnifications: Stability

High image resolution and end magnification place new demands on the stability of the stand system of this stereomicroscope. All relevant components were designed and built according to the most modern methods. The stands feature a significantly higher rigidity and is considerably less susceptible to vibrations than previous systems. The motor focusing makes fine focusing in intervals of 350 nm in a range of 340 mm for loads of up to 17 kg possible.

1. With SyCoP, even the most complex stereomicroscopic operation procedures can be handled comfortably. Without letting the sample out of your sight. With one hand, reliable and flawless.

2. The new SteREO Discovery.V12 zoom body is parfocally adjusted. For pin sharp pictures in the complete magnification range.

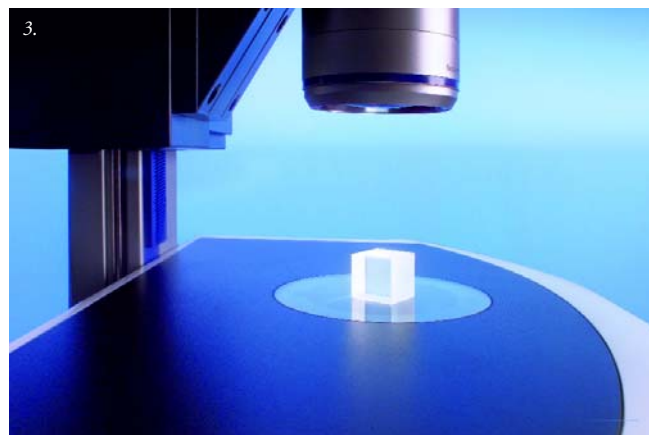
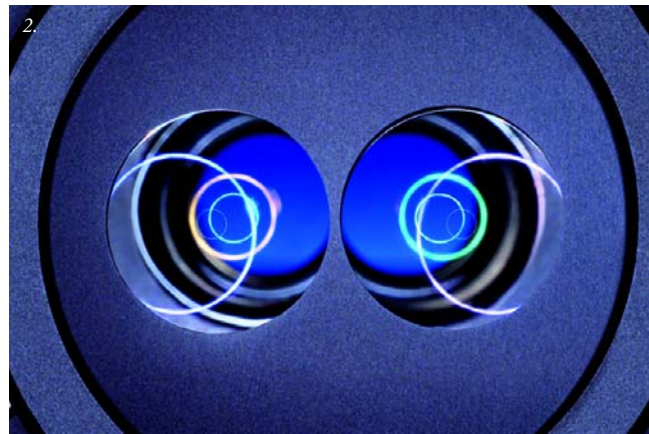

3. Extraordinarily large working area: the stand design with decentralized profile column S.



Intelligent operation: SyCoP

SyCoP stands for **S**ystem **C**ontrol **P**anel and for a considerable gain in time, overview capability and flexibility in the operation of increasingly complex operation procedures. Designed especially for the demands of stereomicroscopy, the novel operation concept combines joystick, keys and touch screen in the handy design of a computer mouse. With SyCoP, almost all important microscope functions can be controlled virtually location-independent. Fast, precise and reproducible. Without removing your eye from the eyepiece ocular. Your attention stays on the object. In addition, SyCoP provides current data about the total magnification, object field, resolution and depth of focus of your microscope setting. SyCoP is an option for the future. New functions and further accessories are integrated through the open CAN-Bus concept.

Increase free space:

Zoom factor 20:1

The largest range from overview to detail – SteREO Discovery.V20 has brought a new zoom range into the research laboratory. And what's more: even the basic configuration of this top stereomicroscope offers an end magnification of 150x. Equipped with the nosepiece S. cod as well as the objectives PlanApo S 0.63x, PlanApo 1x and PlanApo S 2.3x, SteREO Discovery.V20 covers a magnification range from 4.7 to 345x. That is a factor of 73! With only one turn of the nosepiece.

Decide economically:

The SteREO Discovery upgrade concept

SteREO Discovery offers a wide spectrum of compatible modules and accessory components. No matter what instrument type you choose, you have the freedom to upgrade your system according to your needs at any time. Up to the highest-capacity Imaging System that stereomicroscopy has to offer currently.



Sophisticated and universally compatible: the wide accessory range fits for every instrument type of the SteREO Discovery generation.

SteREO Discovery.

The Technology Factor: Exceeding the Limits

Better 3D images, higher resolution, larger zoom ranges – technologically, the conventional stereomicroscope has reached its limits. Each lens, each mechanical detail exhibits tolerances – regardless of the precision of the production. The higher the demands on resolution and magnification become, the less acceptable are these tolerances.

At the limits:

The conventional technology

The centerpiece of a CMO stereomicroscope is the pancrat (microscope or zoom body). During zooming, lenses are moved and must be brought into a certain position in relation to other securely installed lenses with extraordinary precision. Until now a mechanical curve – a simple metal piece milled with great care – determined largely parts the exactness of the traverse path of these lenses and thereby the overall microscope quality. The precision required for new stereomicroscope generations can no longer be fulfilled in this way.

The solution:

The new active principle

On the SteREO Discovery.V20, this mechanical curve has been replaced by a virtual one. The movable lenses are moved with a stepping motor and positioned exactly with a processor. The microscopic images then stay considerably sharper. That has some definite advantages for your research applications:

- **3D images can be viewed in the stereomicroscope in a noticeably more relaxed way**

The partial images which are produced for our eyes are much sharper and better coordinated. The effort of the brain to create a 3D image is less.

- **Sharper images produce contrast improvements**

Particularly decisive when the stereomicroscope is used in high and the highest magnifications. Microscopy pushed to the limits of useful magnification.

- **Higher magnifications with a larger zoom range**

Until recently a zoom with a factor of 16 but not higher was considered technically possible but this limit can now be exceeded considerably with this new technology. And it's affordable.

Carl Zeiss has created a new milestone in stereomicroscopy with the SteREO Discovery.V20. Over 30 invention disclosures and patent applications are providing that this technological advantage is preserved.

Fast, flexible and effective: the final assembly of the stereomicroscope SteREO Discovery in the clean rooms of Carl Zeiss Microscopy GmbH in Jena. It is customized as "individual item chain production according to the Wertstrom design criteria".



1. Before the assembly begins each lens is exactly calibrated against a "0-lens type". This lens value is digitally saved in a data pool – the basis on which computer-calculated combinations are established. By doing this, an optimally coordinated lens family is developed for every individual microscope
2. Rotating reflexes of a lens. As soon as it is in the circle...
3. ... a moveable micro clapper of the computer-controlled glue leveling machine autonomously undertakes the fine alignment.
4. After being moved into place, the lenses are immediately fixed. Precision tools automatically lay high-precision, uninterrupted glue beads through a strong cannula 0.5 mm wide.
5. Hardening of the glue beads under UV-radiation.
6. In the pancrat adjusting device, the precise procedures of all moveable optical elements are programmed. To do this, around 7000 supporting points are analyzed via computer. In doing so, each stereomicroscope obtains its own correction – its own individual zoom control curve.

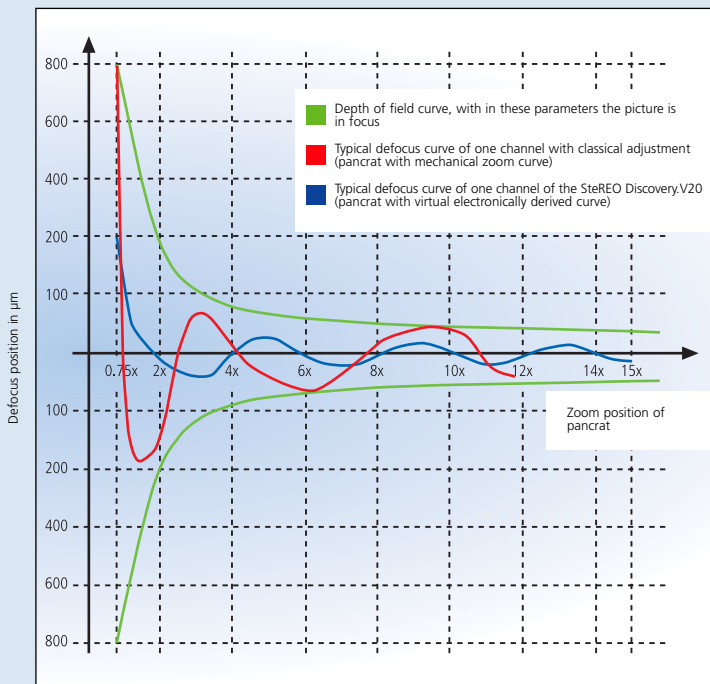
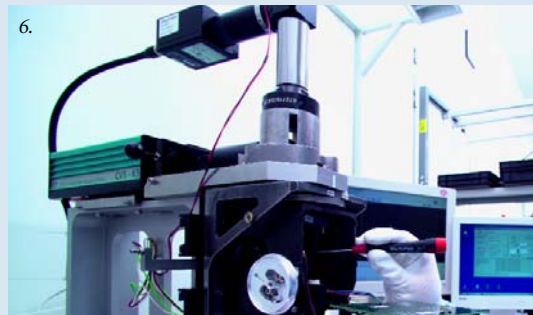
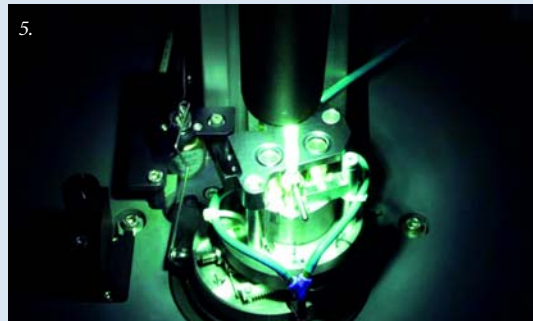
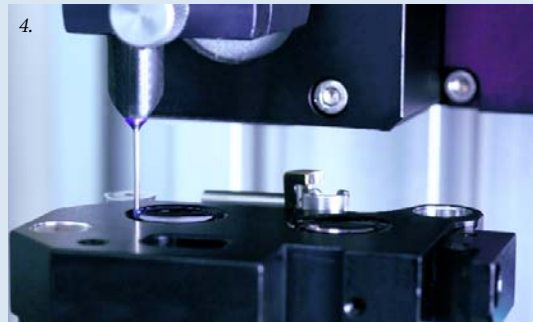
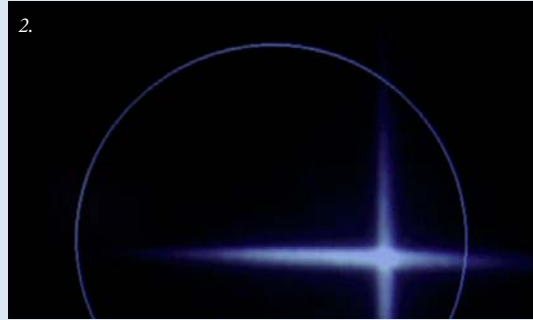
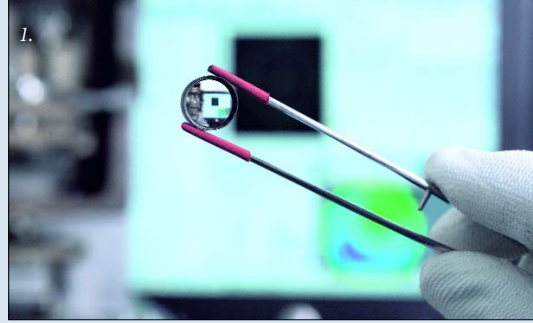

Illustration of the defocus curve of a classical mechanical pancrat in comparison to a motorized one (SteREO Discovery.V20). It is clear that the motorized pancrat differs from the 0 line about half less than the mechanical one. That means: SteREO Discovery.V20 with motorized pancrat delivers twice as sharp images.

The Flexibility Factor: the Upgrade Possibilities are Endless

The modular construction of the SteREO Discovery.V20 is typical for main lens stereomicroscopes. The multitude of accessory components which you can have installed on the high-capacity stereomicroscope in order to create an effective observation and documentation system is correspondingly wide. The flexibility is unusual: completely integrated into the Carl Zeiss system world and equipped with intelligent interfaces, each component can be installed for every instrument type in the SteREO Discovery range.

1. Tubes

Today ergonomics is a basic demand on microscopy. The user's posture should remain relaxed even over long periods of work. An important factor for this are the observation tubes. The eyepiece sockets are swingable and adjustable in two levels. With the ergotube the angle of vision can be individually adjusted between 5 and 45 degrees.

2. Objectives

Objectives largely determine the image quality – and they are a relevant economic factor. The selection of objectives for the SteREO Discovery.V20 receives special attention for a reason. The spectrum

ranges from the cost-effective objectives of the Achromat series to the high-capacity Plan-Achromat objectives to the Plan-Apochromat series, which meets the highest requirements.

3. Stages

Designed to move your objects gently and jolt-free during observation – a wide spectrum of different stages is available for the SteREO Discovery.V20. According to your needs, choose from sliding, rotating, mechanical or ball-and-socket stages. The motorized mechanical stage offers an additional advantage in precision when adjusting and controlling objects: precisely accurate, fast and reproducible.

4. Fluorescence

PentaFluar S is the retrofittable intermediate tube with a coaxial fluorescence mechanism which converts your SteREO Discovery.V20 into a high-capacity fluorescence system. The filter turret holds up to five filter modules and there are also many possibilities regarding illumination. Besides the well-established HBO lamps, X-Cite 120 with a liquid lightguide is recommended.



teREO Discovery.V20

5. Cameras

The demands on the documentation of microscopic images in research are as different as the projects themselves. The spectrum of digital microscope cameras for the innovative high-performance system SteREO Discovery.V20 is correspondingly diverse. Starting with digital consumer cameras through to professional cameras of the microscope camera family AxioCam, Carl Zeiss offers you a suitable price and performance class for every demand.

6. Illumination

The quality of illumination essentially determines the quality of the results – in particular with stereomicroscopic contrasts. With an elaborate system of interfaces and adapters, SteREO Discovery.V20 can be equipped with modern fiber optic LED-components. Optimal for the illumination and contrasting of various objects.

7. Operation

Completely motorized, SteREO Discovery.V20 offers reproducibility and considerable simplifications for your experiment procedures. In particular for controlling object details as well as for setting illumination and contrasts. In addition, the innovative control system is now available. Designed to be user-friendly

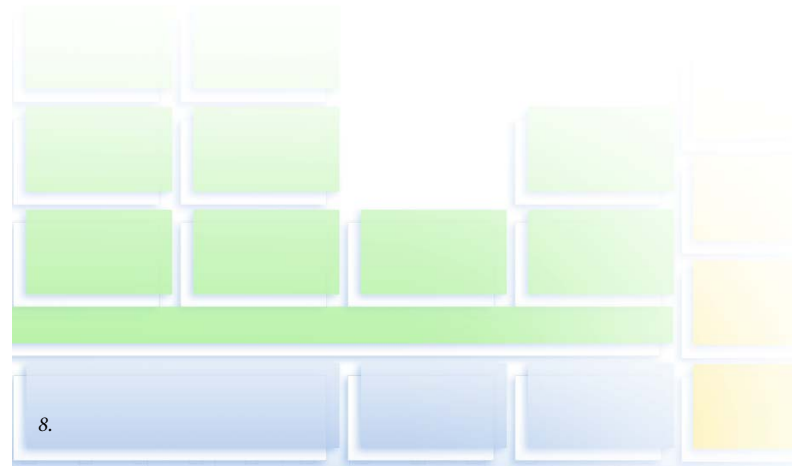

and securely operable. This is the foundation of the fact that the control of the current highest-capacity stereomicroscopy research device practically runs itself.

8. Microscope Software

AxioVision is the superior software for microscope control, image acquisition, image processing, image administration and archiving. With a universal modular design and upgradeable according to your needs from the basic version to the most demanding special configuration. The microscope software from Carl Zeiss is completely integrated to the current highest-capacity analysis platform and holds a top position worldwide on account of its simple operation principle and its high productivity.



Practical Life Sciences: High Magnifications, Excellent Depth Perception

True to reality, completely shift-free 3D imaging of the researched specimen are the demands of contemporary stereomicroscopy. From a complete overview down to the smallest detail like organs, tissues and neurons. Now, Carl Zeiss raises the bar even higher.

SteREO Discovery.V20 with its zoom of 20x doesn't just deliver a large magnification range, it also shines with a brilliant image quality in the research of living specimen and other objects of Life Science. The consequent minimization of stray light of all tubes, the zoom body and the objectives as well as the individually tailored zoom curve, allow for a rich contrast in the images over the entire zoom range – from the overview up to the highest magnification. The large base and the grand front lens add to the unique 3D effect.

Therefore the SteREO Discovery.V20 ensures an image quality that you can count on in research facilities and laboratories of biology and medicine. It is also ideal to observe and research model organisms of developmental biology.

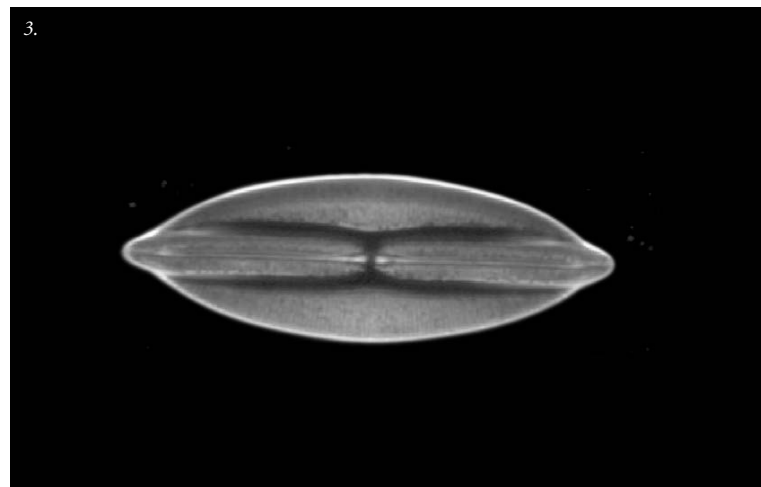
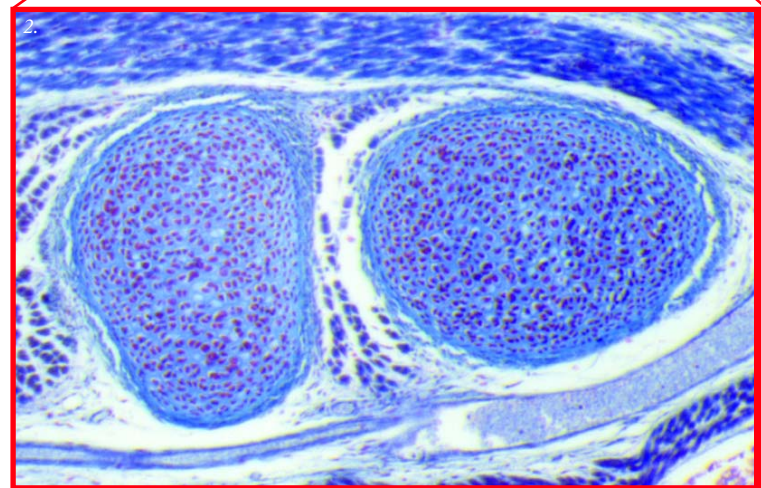
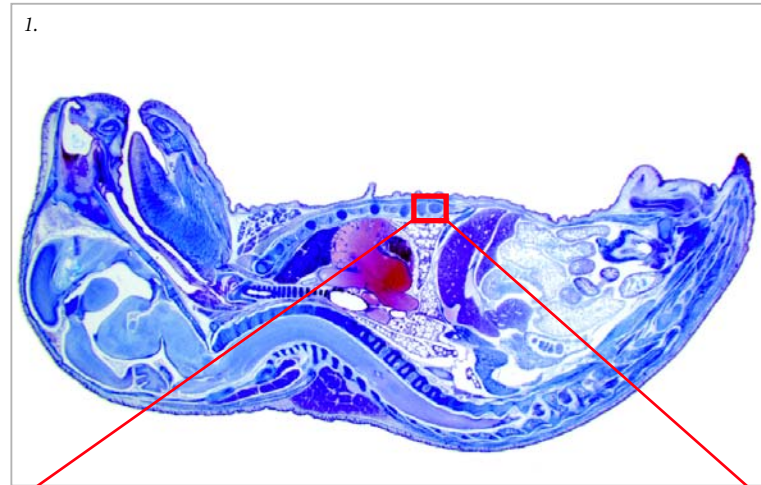

1. Mouse embryo, stained, transmitted-light brightfield,
objective PlanApo S 0.63x, magnification 4.7x*

2. Mouse embryo, stained, transmitted-light brightfield,
objective PlanApo S 0.63x, magnification 94x*

3. Diatome, transmitted-light darkfield,
objective PlanApo S 2.3x, magnification 345x*

Practical Materials: 99% Reproducibility, 100% Investment Security

The demands for high-end stereomicroscopes rise with the perception of smaller details. On one hand there is the need for fast orientation of where you are in the specimen and that requires a large overview. On the other hand there is the need for observing and documenting the smallest detail in a rapid switch from the overview image – ideally without re-focussing.

The SteREO Discovery.V20 with a zoom of 20x gives you a vast advantage in your lab. It is the only stereomicroscope that allows a fast switch from overview to detail image. Here the motorised zoom delivers a precise and free to choose zoom position. And it only differs less than 1%. That means a reproducibility of more than 99%! This is the precision of an ideal research instrument with its always correctly scaled images to measure and document tasks in micromechanics and quality control. And it is a safe investment into a new dimension of achievement.

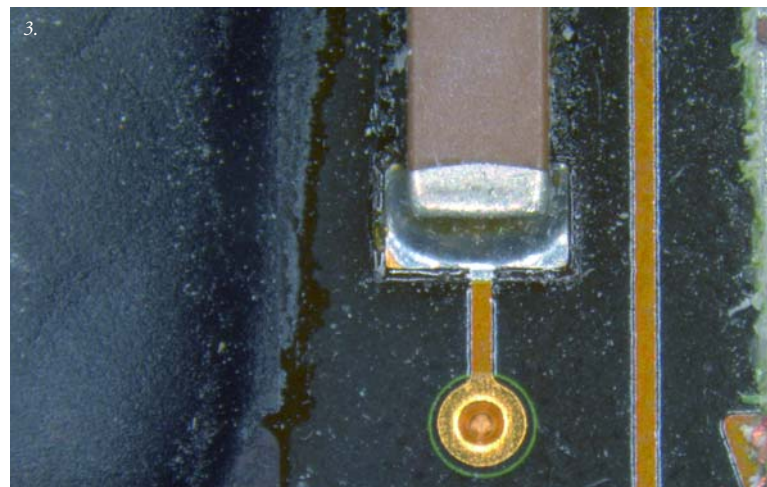
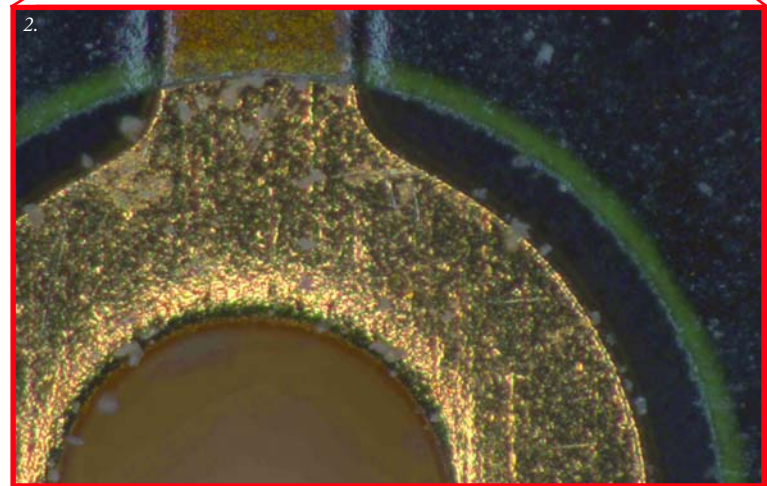
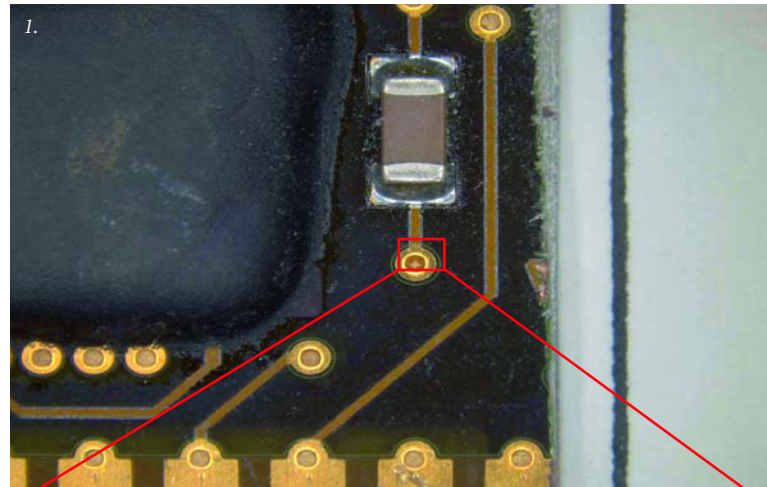

1. Semiconductor, reflected-light darkfield, objective PlanApo S 1x, magnification 7.5x*
2. Semiconductor, reflected-light darkfield, objective PlanApo S 1x, magnification 150x*
3. Semiconductor, reflected-light darkfield, objective PlanApo S 1x, magnification 20x*, Extended Depth of Focus

* Total magnification through eyepieces

SteREO Discovery.V20:

The Technical Data

Objectives		Eyepieces					
Description	FWD (mm)	WPL 10x/23 Br. foc		PL 16x/16 Br. foc		W 25x/10 foc	
Factor		Magnification	Object Field (mm)	Magnification	Object Field (mm)	Magnification	Object Field (mm)
PlanApo S 0.63x	81	4.7x ... 94.5x	48.7 ... 2.4	7.6x ... 151x	33.9 ... 1.7	11.8x ... 236x	21.1 ... 1.1
PlanApo S 1.0x	60	7.5x ... 150x	30.7 ... 1.5	12x ... 240x	21.3 ... 1.1	18.8x ... 375x	13.3 ... 0.7
PlanApo S 1.5x	30	11.3x ... 225x	20.4 ... 1.0	18x ... 360x	14.2 ... 0.7	28.1x ... 563x	8.9 ... 0.4
PlanApo S 2.3x	10	17.3x ... 345x	13.3 ... 0.7	27.6x ... 552x	9.3 ... 0.5	43.1x ... 863x	5.8 ... 0.3
PlanApo S 3.5x mono	16	26.3x ... 525x	8.8 ... 0.4	42x ... 840x	5.5 ... 0.27	65.6x ... 1312.5x	3.5 ... 0.18
Plan S 1.0x	81	7.5x ... 150x	30.7 ... 1.5	12x ... 240x	21.3 ... 1.1	18.8x ... 375x	13.3 ... 0.7
Achromat S 0.3x	253	2.3x ... 45x	102 ... 5.1	3.6x ... 72x	71.1 ... 3.6	5.6x ... 113x	44.4 ... 2.2
Achromat S 0.5x	151	3.8x ... 75x	61.3 ... 3.1	6x ... 120x	42.7 ... 2.1	9.4x ... 188x	26.7 ... 1.3
Achromat S 0.63x	115	4.7x ... 94.5x	48.7 ... 2.4	7.6x ... 151x	33.9 ... 1.7	11.8x ... 236x	21.1 ... 1.1
Achromat S 1.0x	69	7.5x ... 150x	30.7 ... 1.5	12x ... 240x	21.3 ... 1.1	18.8x ... 375x	13.3 ... 0.7
Achromat S 1.5x	28	11.3x ... 225x	20.4 ... 1.0	18x ... 360x	14.2 ... 0.7	28.1x ... 563x	8.9 ... 0.4

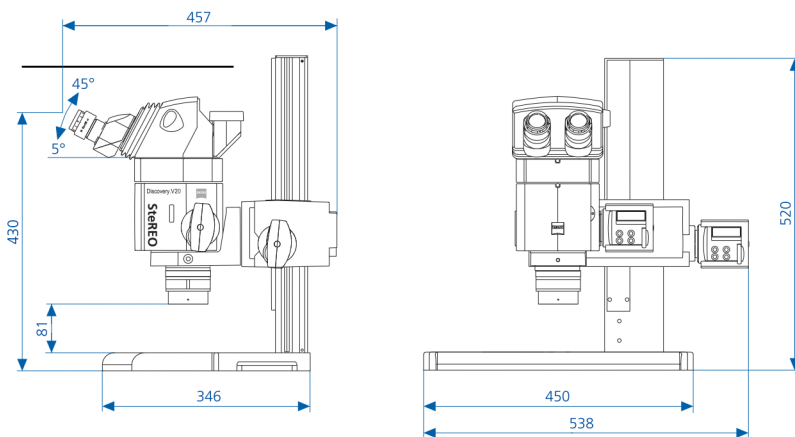

MICROSCOPY • METROLOGY SERVICES
Suisse made



We show quality
Nous rendons la qualité visible
Wir machen Qualität sichtbar



Bettlachstrasse 2 | 2540 Grenchen | Switzerland
phone +41 32 654 21 00 | +41 22 776 82 28
ryfag@ryfag.ch | www.ryfag.ch

Printed on environmentally-
friendly paper, bleached without
the use of chlorine.
Subject to change.