

**Stemi 305 MAT microscope set**  
435063-9030-100

**Stemi 305 EDU microscope set**  
435063-9010-100

**Stemi 305 LAB microscope set**  
435063-9020-100

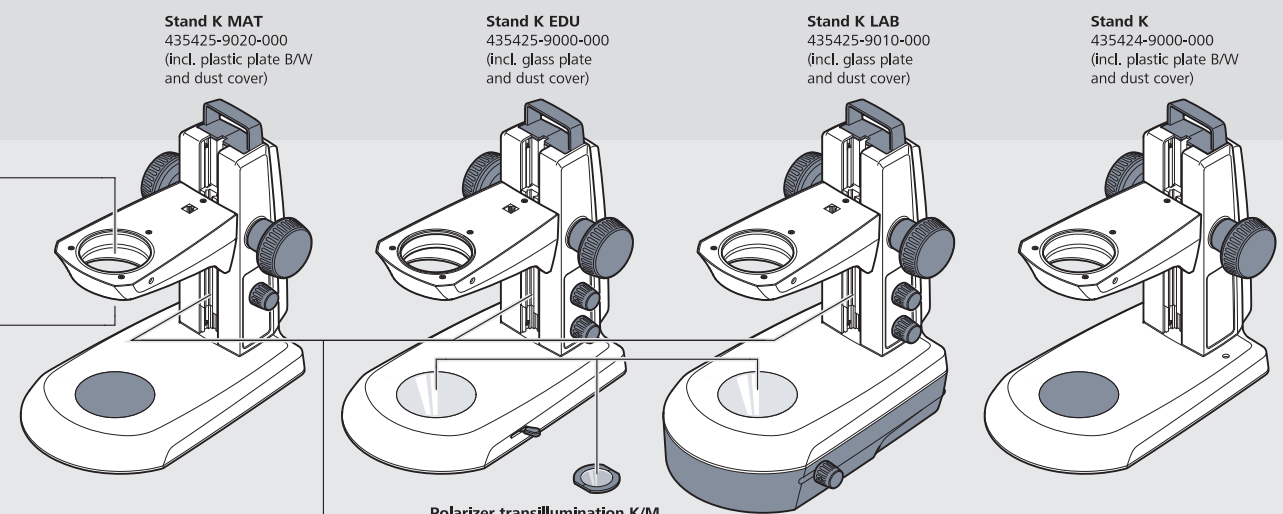
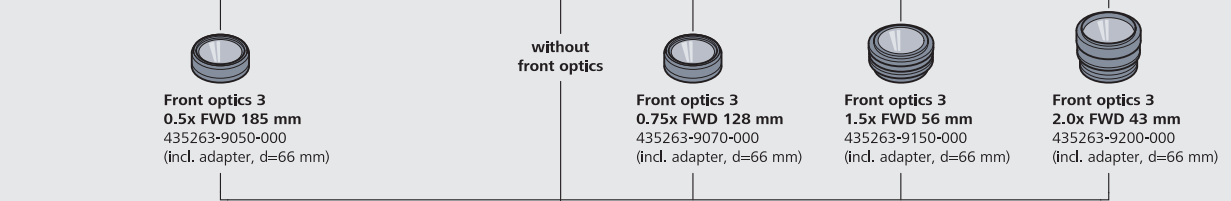
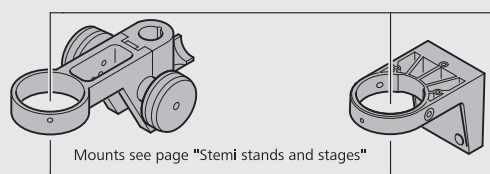

**Polarizer transillumination K/M**  
435526-9020-000

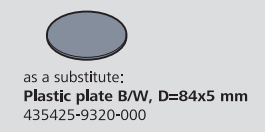
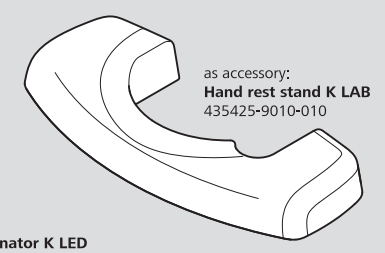
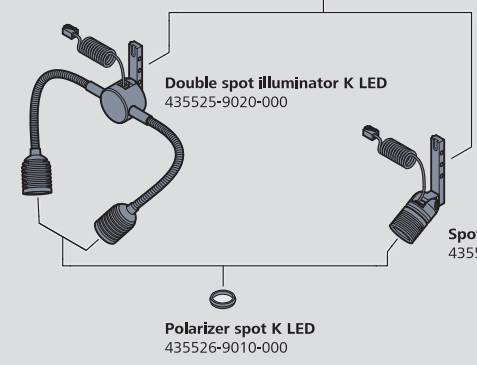
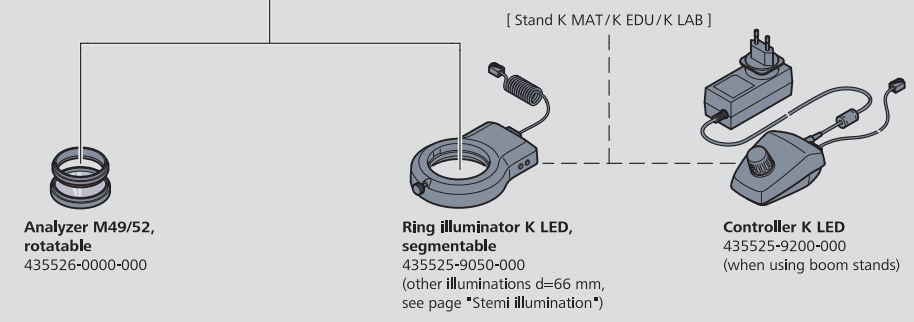

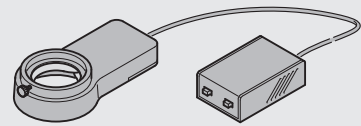

**Ring illuminator with neon tube 5500 K, d=58/66 mm**  
417040-9100-000  
(incl. control unit and power supply)

**Holder, d=66 mm to VisiLED DF**  
417095-9510-000

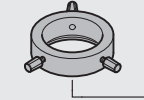

**VisiLED ring light S, 80-25 BF, d=66 mm**  
417095-9225-000 (without fig.)  
**VisiLED ring light S, 80-55 BF, d=66 mm**  
417095-9255-000

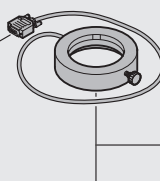

**Set for simultaneous fixing VisiLED BF+DF**  
417095-9500-000

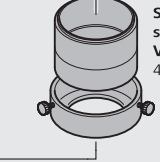

**Polarization filter set VisiLED/EasyLED**  
417095-9550-000



**LED double spot for mount S 76 mm**  
417040-9560-000 (without fig.)  
(incl. LED control unit HiPower, power supply and adapter)

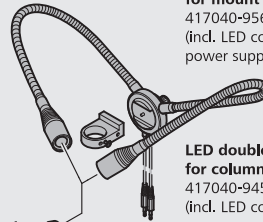

**LED double spot for column 32**  
417040-9450-000  
(incl. LED control unit HiPower, power supply and adapter)

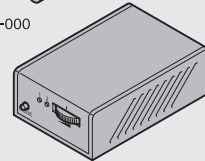

**EasyLED spot polarizer**  
417096-9600-000

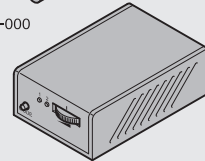

**VisiLED ring light S 40-10 DF, d=66 mm**  
417095-9300-000

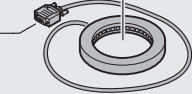

**Power supply 100...240 V, 50...60 Hz for VisiLED**  
417095-9050-000

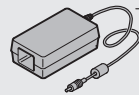

**Controller MC 1000 for VisiLED**  
417095-9040-000  
(for 1 VisiLED light)

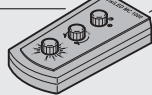

or:  
**Multiple controller MC 1500 for VisiLED**  
417095-9000-000 (without fig.)  
(for 2 VisiLED light)

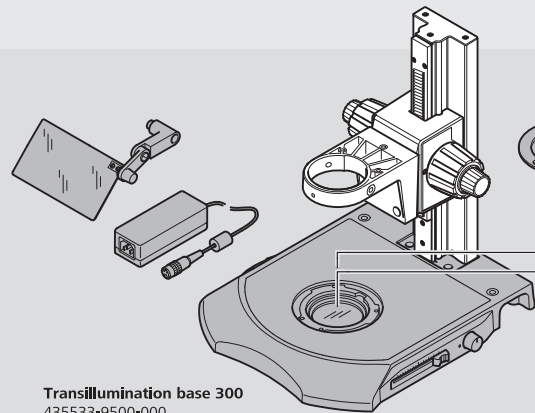

**Transillumination base 300**  
435533-9500-000  
incl.:  
- Clear glass plate, D=120 mm  
- Insert diaphragm 28/84  
- Power supply 24 V, 60 W  
- Antiglare shield

[ Stage ]

**Stage adapter 84+120 for transillumination base 300**  
435533-9510-000

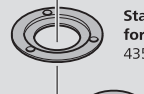

**Polarizer S D=84 mm**  
435531-0000-000



**Cold light source CL 1500 HAL**  
435710-9000-000  
**Conversion filter, D=28 mm**  
000000-1063-317 (without fig.)

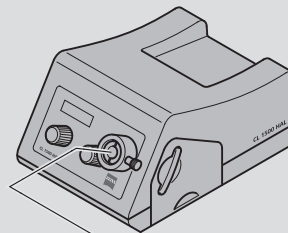

**Cold light source CL 4500 LED CR190**  
435700-9200-000

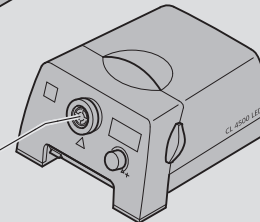

**Transmitted-light unit S with light guide 1500, 8/1000 mm**  
000000-1003-877

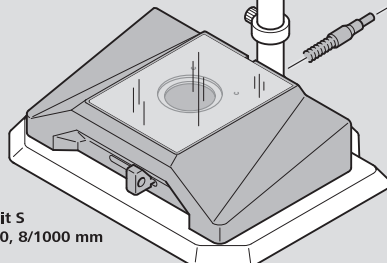

**Spacing ring S, d=66x57 mm**  
435448-0000-000  
**Spacing ring S, d=66x40 mm**  
435449-0000-000  
(without fig.)



**Slit-ring illuminator 1500 for incident-light darkfield, d=66 mm**  
417075-9011-000



**Diffuser S, telescopic, d= 66 mm/M8**  
435507-0000-000



**Slit-ring illuminator 1500 ECO, d=66 mm, 9/1000 mm**  
435540-9005-000



**Slit-ring illuminator 1500 ECO, d=66 mm, 9/2000 mm**  
435540-9006-000 (without fig.)



**Vertical illuminator S, d=66 mm, adjustable**  
435505-9000-000



**Flexible light guide 1500, 5/1000 mm**  
417075-9100-000



**Polarization filter set S, d=66 mm**  
417075-9009-000



[ M8 hole in stand component ]

**Clamping ring 2x M8 to column 32**  
435444-0000-000



**Illuminator carrier S, M8-M8**  
435441-0000-000



**Clamp S to light guide**  
435442-0000-000



**Articulated arm S, M8-M8**  
435443-0000-000

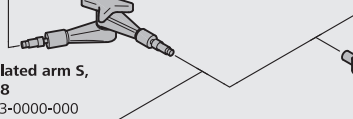

**Flexible light guide 1500, 8/1000 mm**  
417063-9901-000  
**Flexible light guide 1500, 5.6/2000 mm**  
417069-9001-000 (without fig.)

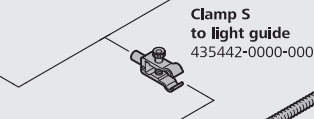

**Flexible light guide 1500 ECO, 2x 4.5/1000 mm**  
435540-9002-000  
**Flexible light guide 1500 ECO, 4.5/800 mm**  
435540-9001-000 (without fig.)

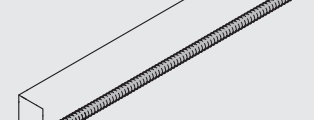

**Focusing attachment, d=10 mm**  
417089-0000-000



**Focusing attachment, d=6 mm, without filter**  
435540-9003-000

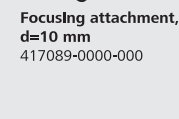

**Polarizer for focusing attachment**  
417065-0000-000

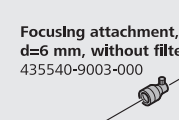

**Focusing attachment and filter set**  
417060-9901-000



**Goose-neck light guide 1500-90°, 2x 4.5/560 mm**  
417040-9210-000  
**Goose-neck light guide 1500, 4.5/600 mm**  
417052-9901-000 (without fig.)

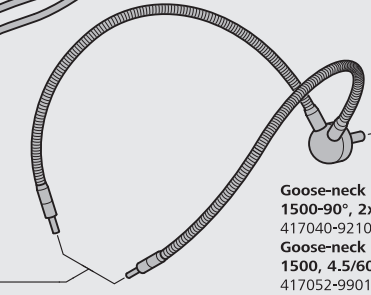

**Line light S, l=50 mm**  
000000-1063-307

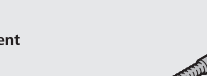

**Diffuse facelight M8 with light guide**  
435508-0000-000

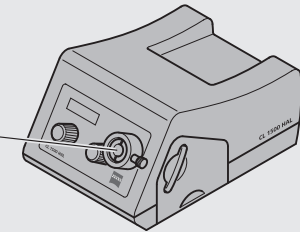

**Cold light source CL 1500 HAL**  
435710-9000-000  
**Conversion filter, D=28 mm**  
000000-1063-317 (without fig.)

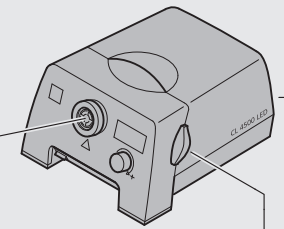

**Cold light source CL 4500 LED CR190**  
435700-9200-000

**Blue filter for CL LED**  
435700-9022-000  
**Green filter for CL LED**  
435700-9023-000  
**Yellow filter for CL LED**  
435700-9024-000  
**Red filter for CL LED**  
435700-9025-000  
**Neutral filter 0.25 CL LED**  
435700-9026-000  
**Halogen light filter CL 4500 LED**  
435700-9219-000

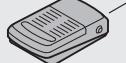

**Foot button S**  
435602-9010-000

Mounting frame or plate 160x116 mm  
of the mechanical stages from Axio Imager

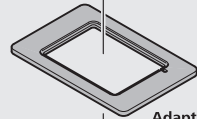

**Adapter frame S**  
160x116 mm, epi-illumination  
435465-9050-000

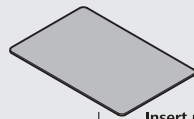

**Insert plate S, metal**  
237x157x3 mm  
435465-9052-000

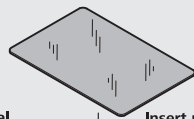

**Insert plate S, glass**  
237x157x3 mm  
435465-9053-000



**Mounting frame 116x116/84 mm**  
435461-9001-000

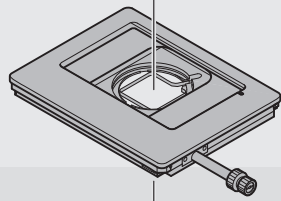

**Mechanical stage S**  
150x100 R  
435465-9010-000

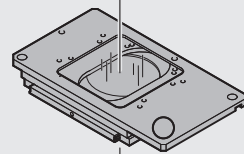

**Gliding stage S**  
110x110, d=120 mm  
435461-0000-000  
(incl. glass plate)

**Plastic plate B/W**  
475290-9901-000



**Ground glass plate**  
475291-0000-000



**Clear glass plate**  
475265-0001-000



**Adherently coated plate**  
475288-0000-000

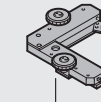

**Specimen guide 75x25  
for slides**  
413455-0000-000

as a substitute:  
**Glass plate D=72 mm**  
473378-0000-000

**Rotating Pol stage  
for stereo microscopes**  
455120-9901-000  
(incl. glass plate D=72 mm  
and two stage clips)

**Polarizer S**  
455174-0000-000

**Stage clips**  
473371-9902-000

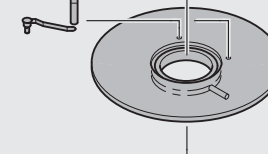

**Gliding stage**  
455122-0000-000

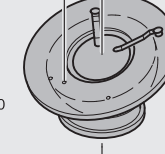

**Ball-and-socket stage**  
455123-9901-000  
(incl. adherently coated plate  
and two stage clips)

**Lambda plate  
in slider**  
455172-0000-000



**Stage adapter 84/120**  
435430-9010-000



Microscope body interface  
d=76 mm

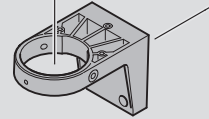

**Mount S  
with diam. 76 mm support**  
435402-0000-000

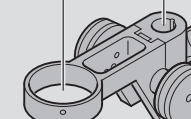

**Stemi mount with drive  
for column 32**  
455094-9902-000

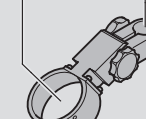

**Stemi mount U 0°-90°  
without drive**  
000000-1222-247

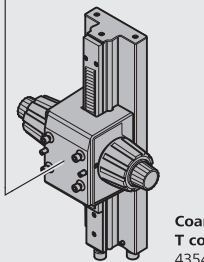

**Coarse/fine drive with  
T column 350 mm**  
435433-9000-000

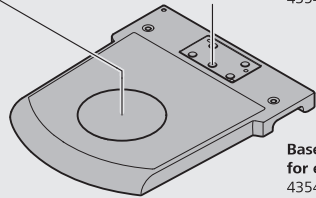

**Base 300  
for epi-illumination**  
435433-9400-000  
(incl. plastic plate B/W,  
D=120 mm)



as a substitute:  
**Plastic plate B/W,  
D=120 mm**  
435430-0120-010

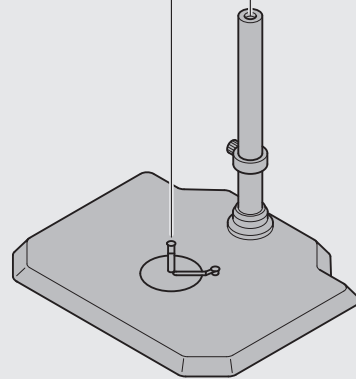

**Stand N  
with 350 mm column  
and plate 370x440 mm**  
455107-0000-000  
(incl. insert plate and two stage clips  
and security ring)

**Stand N  
with 450 mm column  
and plate 370x440 mm**  
455107-9800-000  
(incl. insert plate and two stage clips  
and security ring)

**Non-tilting head  
32/200 to BMS**  
000000-1046-525

**Tilting head  
32/200 to BMS**  
000000-1046-524

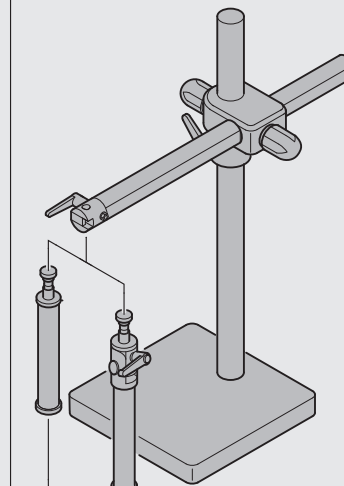

**Stand A**  
consisting of:  
- **Boom A**  
000000-1046-522  
- **Stand base 10/260x260**  
000000-1046-518

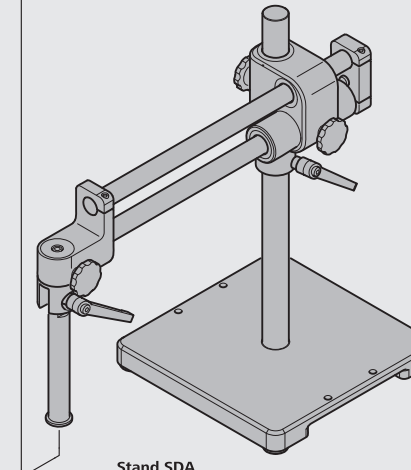

**Stand SDA**  
consisting of:  
- **Twin boom SDA 200-530 mm**  
435411-0000-000  
incl.:  
- Column SDA 40/610 mm  
- Safety ring for height adjustment  
- Twin boom with tilting head  
- Stand head 32/200 mm  
- **Stand base SDA 350x350x50 mm**  
435412-0000-000

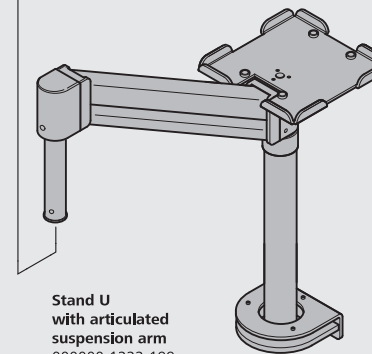

**Stand U  
with articulated  
suspension arm**  
000000-1222-199  
consisting of:  
- Articulated suspension arm U 35/580 mm  
- Stand head U 32/125  
- Console U  
- Table mount U 35/210 mm  
- Table clamp U  
optional:  
- **Traverse U 35/325 mm**  
000000-1222-246

# MICROSCOPY + METROLOGY SERVICES

**Swiss made.**

RYF AG  
Bettlachstrasse 2  
CH-2540 Grenchen  
Tel +41 32 654 21 00

RYF SA Succursale  
Route de Genève 9c  
CH-1291 Commugny  
Tel +41 22 776 82 28

RYF AG (Zürich)  
Bahnhofplatz 17  
CH-8400 Winterthur  
Tel +41 52 560 22 25

[ryfag@ryfag.ch](mailto:ryfag@ryfag.ch)



Wir machen Qualität sichtbar  
Nous rendons la qualité visible  
Making quality visible

[www.ryfag.ch](http://www.ryfag.ch)